

Z.R.E.

... Infinite solutions ...

Thermocouples and RTD

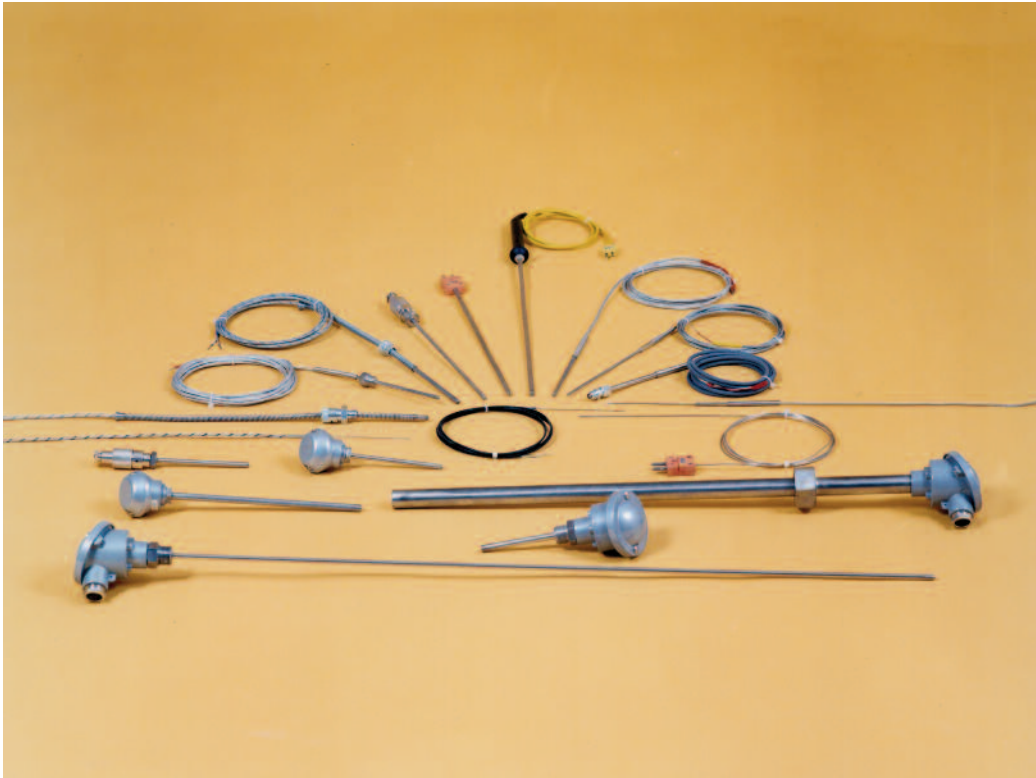

MODEL Z.22

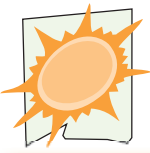

Model Z.22 thermocouples

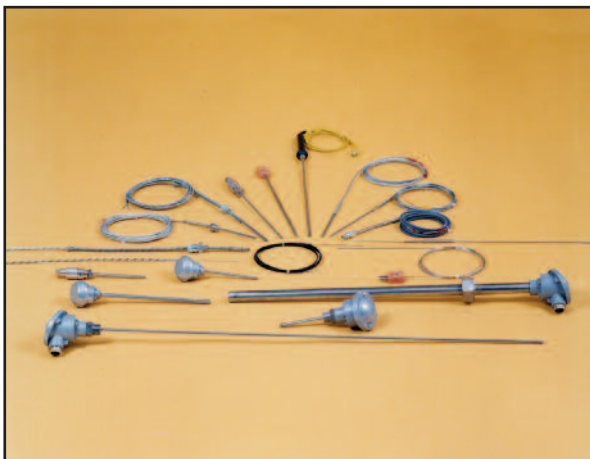

Technical features

Thermocouple are components used for temperature control. A thermocouple is composed by two different metal conductors joined at one end and encapsulated in a metallic tube. As the temperature changes, the voltage reading at the end of the conductors changes too permitting to measure the temperature on the junction.

There are three different way to join the conductors:

- **Insulated thermocouples**

The measuring junction is not in contact with the external sheath. This solution guarantee a good protection from parasitic currents generated by magnetic fields or any other equipment.

Insulated thermocouples are a good balance between protection against interferences and response time.

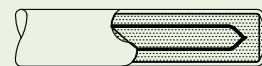

Insulated thermocouples

- **Grounded thermocouples**

The measuring junction is sealed together with the external protection. This solution guarantee a high response time but due to the grounded junction it may suffer interference on the output signal.

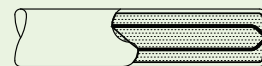

Grounded thermocouples

- **Exposed junction**

The measuring junction is exposed to the atmosphere on the measuring area. being equal the external sheath diameter this solution guarantee the best response time. It is not suitable for measurements at high temperatures and in aggressive environments

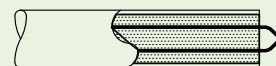

Exposed junction

For further info please, contact our technical dep.

We reserve the right to change technical details.

How to order

- Model Z.22
- Application:
- + Article number (if knows):
- + Diameter:
- + Length (L):
- + Grounded or insulated:
- + Leads length (L2):
- + Leads type:
- + Quantity:
- + Any connection:

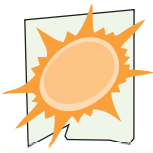

Technical features

Construction

Two ways may be used to construct a thermocouple:

- **MgO insulated**

Those kind of thermocouples are made with Magnesium Oxide insulated leads. Those leads are composed by a metallic external sheath in which the two metal conductors are insulated from each others and from the outer sheath with compressed MgO powder. MgO insulated thermocouples are rugged sensors that guarantee much higher performance than those constructed using the classical method together with high shock resistance and vibrations resistance. They can also be bent in order to adapt them to different application. Response time, possibility of miniaturization and long lifespan are other particular characteristics of the mineral insulated sensors.

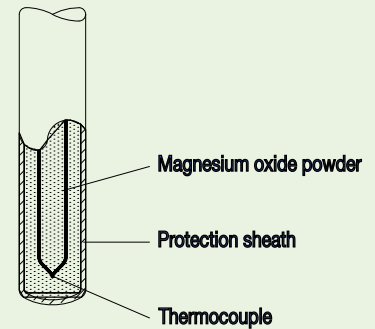

- **With calibrated wires and insulators**

The wires are insulated by an external rigid sheath using ceramic insulators. The outside sheath must provide suitable protection of the wires against gases or corrosive agents that may be present in the measurement environment. Selection of the wires of suitable diameter and type according to the type of working environment is also important. The suitable insulation (ceramic or fibreglass insulation) has to be identified according to the working temperature.

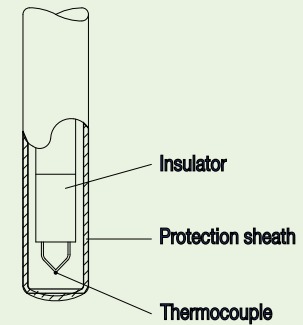

Comparative analysis of performances

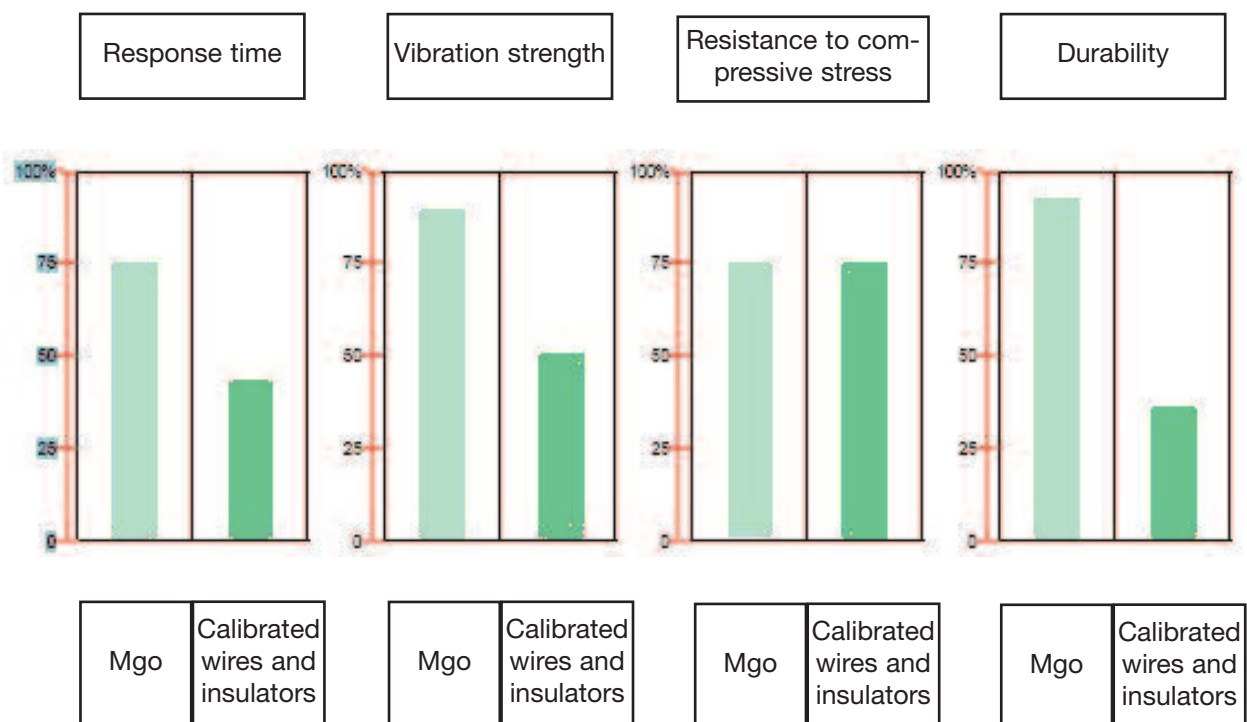

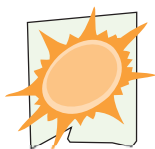

Mineral insulated thermocouple (MGO) with metallic transition

THERMOCOUPLE TYPE J – INSULATED MEASURING JUNCTION

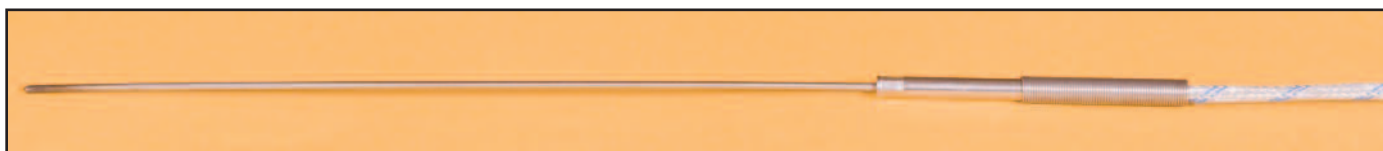
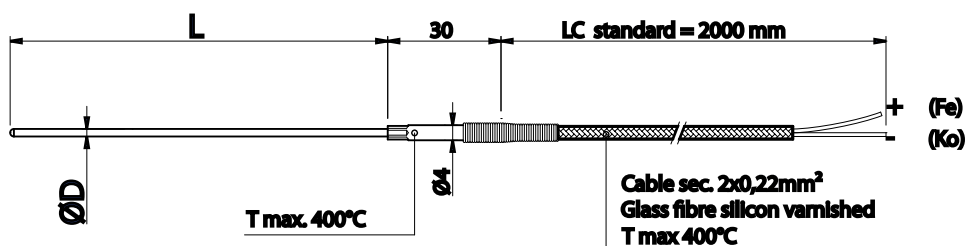

Standard dimensions in stock

Code	TCZ 10DL50 ($\varnothing D$ 1 - L 50 mm)	TCZ 15DL50 ($\varnothing D$ 1.5 - L 50 mm)	
	TCZ 10DL100 ($\varnothing D$ 1 - L 100 mm)	TCZ 15DL100 ($\varnothing D$ 1.5 - L 100 mm)	TCZ 20DL100 ($\varnothing D$ 2 - L 100 mm)
	TCZ 10DL150 ($\varnothing D$ 1 - L 150 mm)	TCZ 15DL150 ($\varnothing D$ 1.5 - L 150 mm)	TCZ 20DL150 ($\varnothing D$ 2 - L 150 mm)
	TCZ 10DL200 ($\varnothing D$ 1 - L 200 mm)	TCZ 15DL200 ($\varnothing D$ 1.5 - L 200 mm)	
Tube material	AISI 316	AISI 316	AISI 316
Conductors Fe/ Cu	Fe cost	Fe cost	Fe cost
Junction: insulated	Insulated	Insulated	Insulated
Max temperature $^{\circ}\text{C}$	-10 +700	-10 +700	-10 +700
Cable LC.2000mm made of fibreglass/fibreglass braided according to DIN norm (red/blue)			

Upon request with Kapton cable



How to bend:

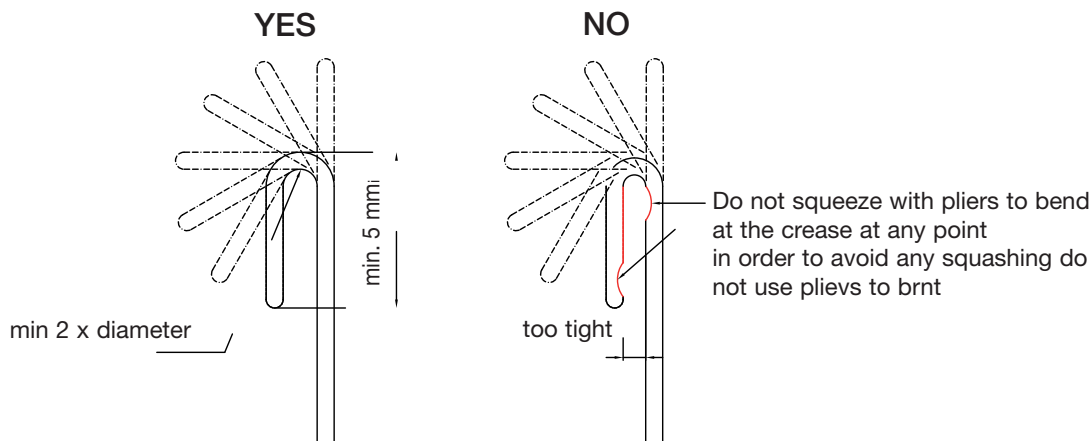

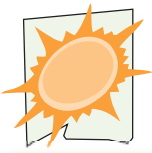

Mineral insulated thermocouples (MGO) with moulded transition

Technical features

General features

Mineral insulated thermocouples with high temperature moulded transition and Kapton leads have been developed mainly for temperature control in injection nozzles and hotrunner systems.

Those thermocouples, available in different diameters and length are made to guarantee best performances in terms of precision, lifespan and mechanical strength

The Moulded transition is completely waterproof and prevent from any possible contact defect, break. Moreover it is guarantee for working temperature up to 400°C

NEW

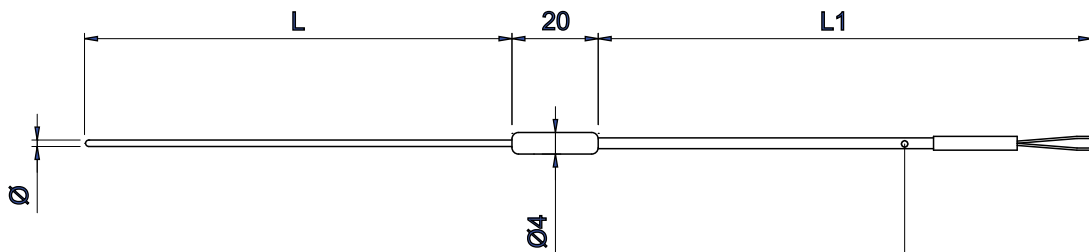

Cable sec. 2x 0,22mm² - Mat. Kapton/Kapton



- Being placed at less than 1.5mm from the tip the sensitive junction guarantees accuracy in temperature reading and a short response time

- Moulded transition.
- Working temperature up to 400°C (peak around 450°C).
- High dielectric strength and mechanical strength.

- Cable section 2 x 0.22 mm²
- Made of Kapton/Kapton
- Working temperature up to 400°C
- According to DIN, ANSI, IEC norm



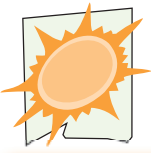

Thermocouple standard in stock

Code	TCZ 3010P
Foil material	Brass
Conductors material	Fe cost
Measuring junction	Grounded
max Temperature °C	-10 +400
Cable L.2000 mm	v.sil/v.sil sch(*)

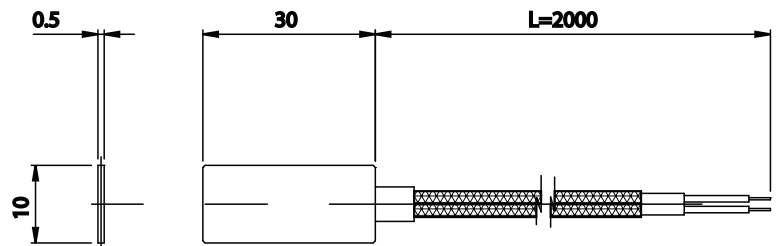

Code	TCZ4025P
Tube material	AISI304
Conductors material	Fe cost
Measuring junction	Grounded
max Temperature °C	-10 +400
Cable L.2000 mm	v.sil/v.sil sch(*)

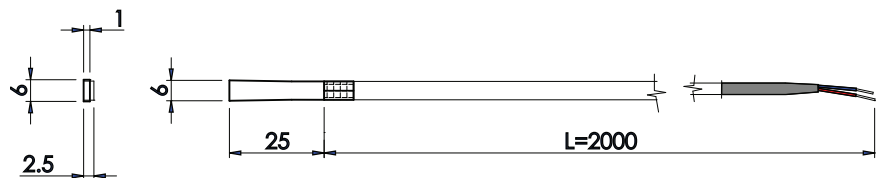

Code	TCZ 3030P
Tube material	AISI 304
Foil material	Brass
Conductors material	Fe cost
Measuring junction	Grounded
max Temperature °C	-10 +400
Cable L.2000 mm	v.sil/v.sil sch(*)

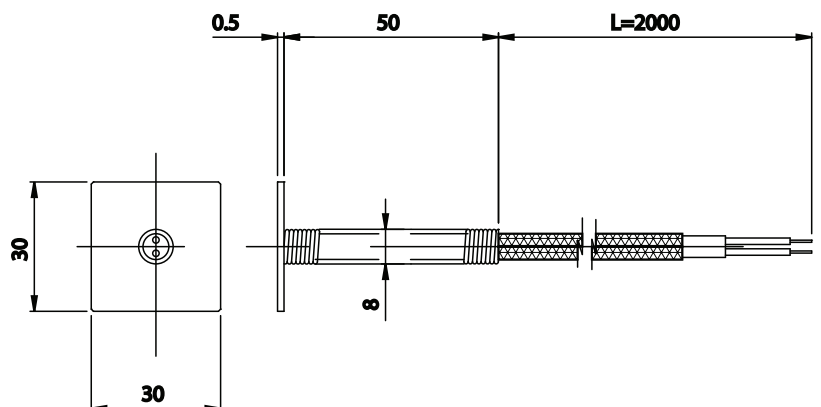

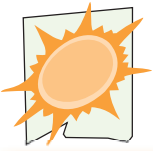

Code	TCZ 5D10D
Eyelet	AISI 304
Conductors material	Fe cost
Measuring junction	Grounded
max Temperature °C	-10 +400
Cable L.2000 mm	v.sil/v.sil sch(*)

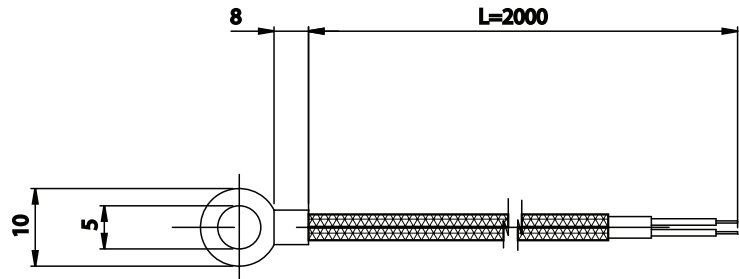

Code	TCZ 5D10DS
Eyelet	Copper
Conductors material	Fe cost
Measuring junction	Grounded
max Temperature.°c	-10 +400
Cable L.2000 mm	Vetrotex

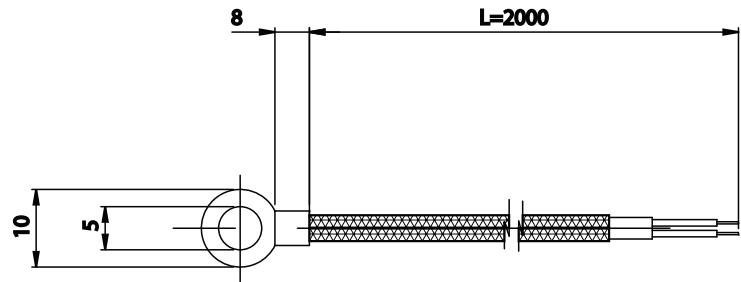
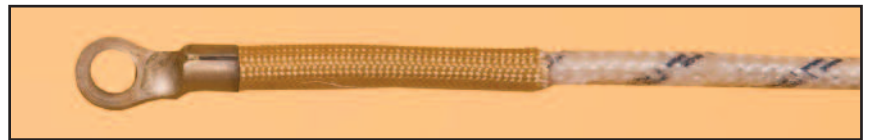

Code	Z22R005010
Conductors material	Fe cost
Measuring junction	Grounded
max Temperature.°c	-10 +400
Cable L.2000 mm	v.sil/v.sil sch(*)

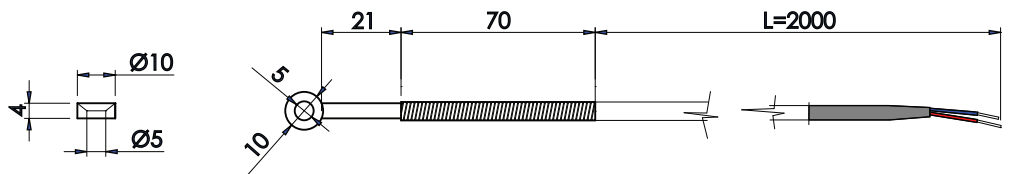
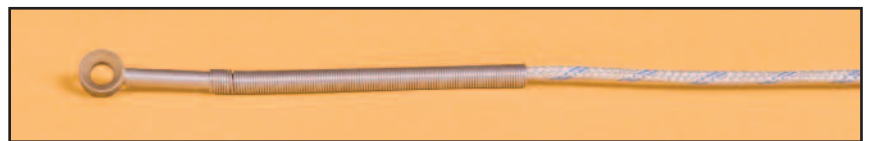

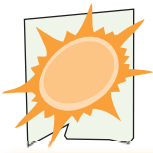

Code	TCZ 2158D4L12
Body material	AISI 304
Test prod material	Nickel plated brass
Conductors material	Fe cost
Measuring junction	Grounded / isolato(*)
max Temperature	-10 +400
Cable L.2000 mm	v.sil/v.sil sch(*)

(*) please, specify in case of order

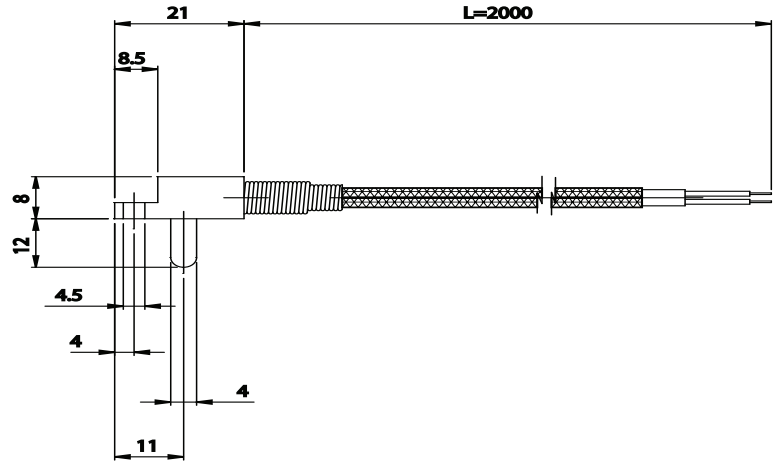
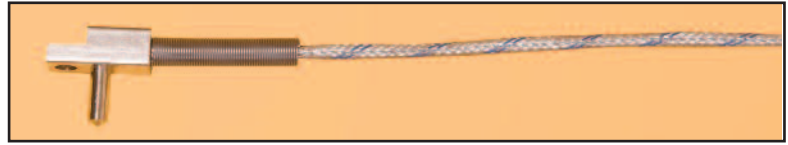

Code	TCZ 2545F TCZ 4670F TCZ7898F
Tube material	AISI 304
Conductors material	Fe cost
Measuring junction	Grounded
max Temperature °C	-10 +400
Cable L.2000 mm	v.sil/v.sil sch(*)

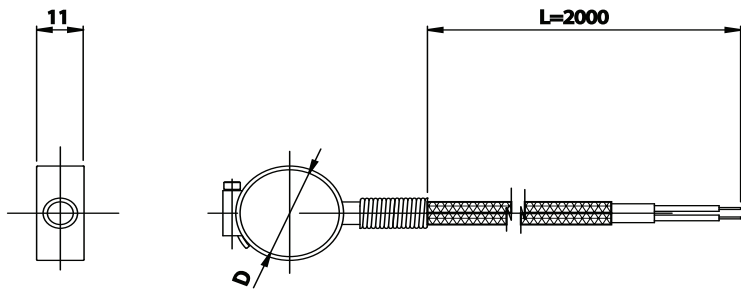
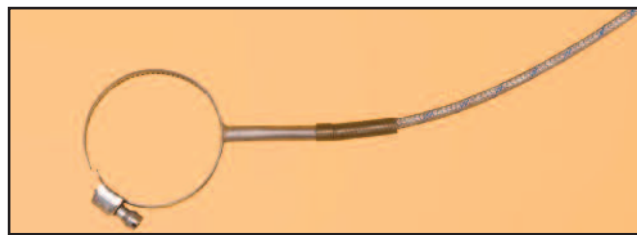

Code	TCZ 4D8MA
Tube material	AISI 304
Conductors material	Fe cost
Measuring junction	Grounded
max Temperature °C	-10 +400
Cable L.2000 mm	v.sil/v.sil sch(*)

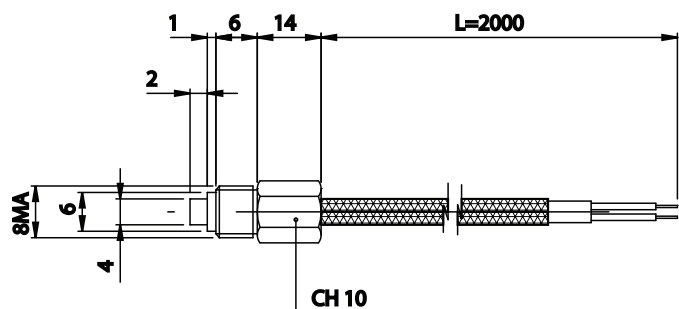

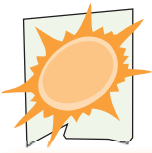

Code	TCZ 5D10MA
Tube material	AISI 304
Conductors material	Fe cost
Measuring junction	Grounded
max Temperature °C	-10 +400
Cable L.2000 mm	v.sil/v.sil sch(*)

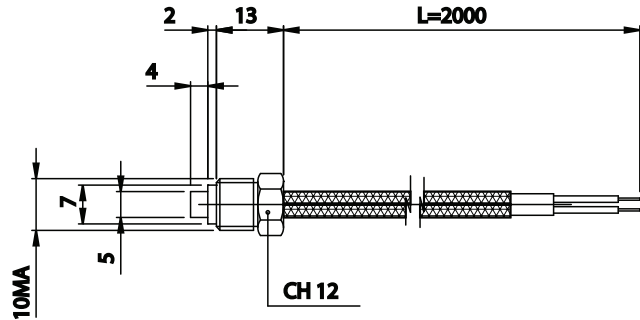

Code	TCZ 4D5MA
Tube material	AISI 304
Conductors material	Fe cost
Measuring junction	Grounded
max Temperature °C	-10 +600
Cable L.2000 mm	v.sil/v.sil sch(*)

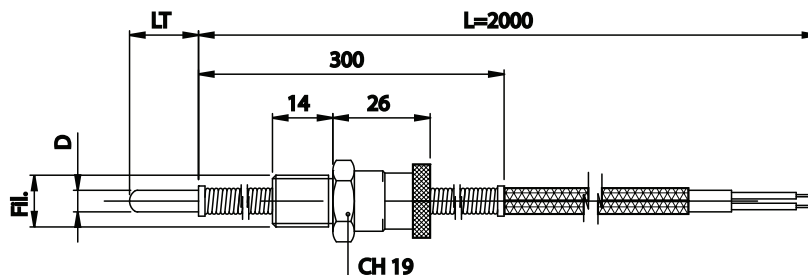
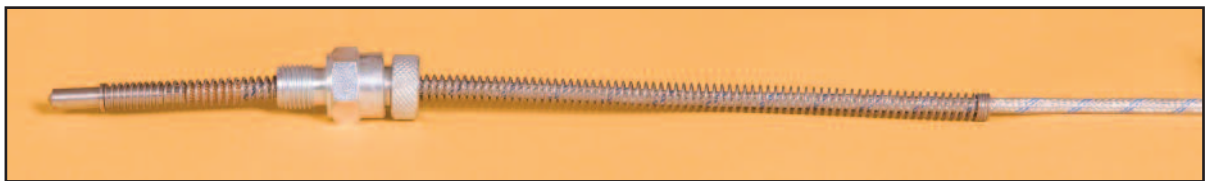
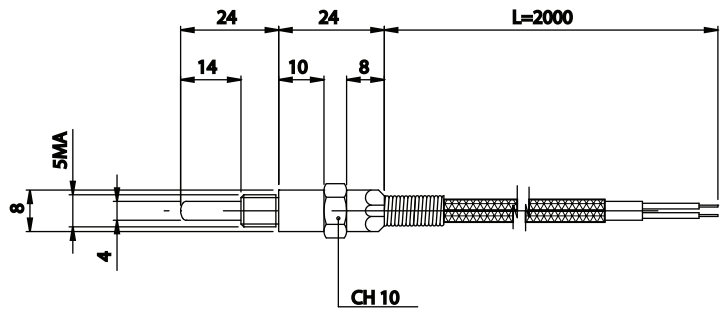

Code	TCZ 5DL15 (Ø 5 - LT 15 mm)	TCZ 6DL15 (Ø 6 - LT 15 mm)	TCZ 6DL35M (Ø 6 - LT 35 mm)	TCZ 8DL15M (Ø 8 - LT 15 mm)	Thread
Tube material	AISI 304	AISI 304	AISI 304	AISI 304	1/4" g 3/8" g 12MA 12MB
Conductors material	Fe cost	Fe cost	Fe cost	Fe cost	
Measuring junction	Grounded	Insulated/Grounded	Grounded	Grounded	
max Temperature °C	-10 +400	-10 +400	-10 +400	-10 +400	
Cable L 2000 mm	v.sil/v.sil sch(*)				

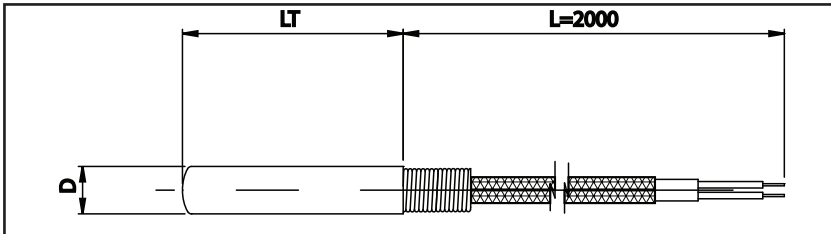
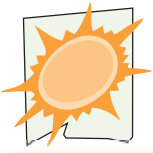

Code	TCZ 5DL120 (ØD 5 - LT 120)	TCZ 6DL90 (ØD 5 - LT 90)
Foil material	AISI 304	AISI 304
Conductors material	Fe cost	Fe cost
Measuring junction	Grounded	Grounded
max Temperature °C	-10 +400	-10 +400
Cavo L 2000 mm	v.sil/v.sil sch(*)	

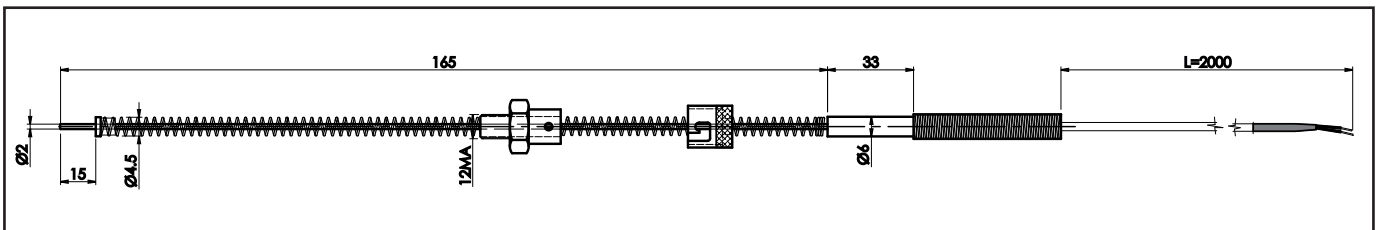

Code	TCZ 2DIB	Thread
Tube material	AISI 304	1/8" g 8MA 1/4" g 10MA 3/8" g 10MA standard 12MA
Conductors material	Fe cost	
Measuring junction	Insulated	
max Temperature °C	-10 +400	
Cavo L 2000 mm	v.sil/v.sil sch(*)	

(*) glass fibre/ glass fibre silicon varnished

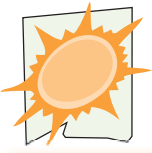

Threaded connections

ØD Threaded connection diameters available in stock:

- 1/4" Gas
- 12 MA
- 12 MB

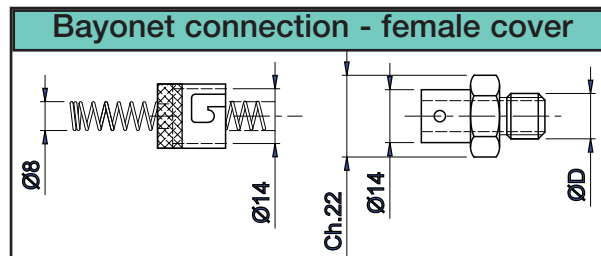
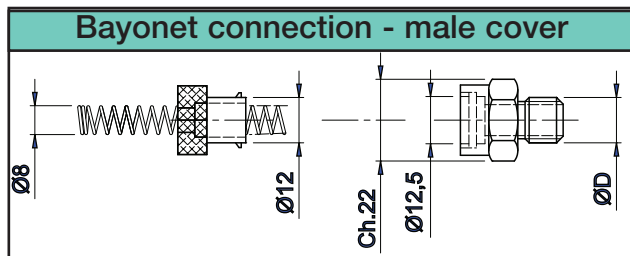

Available thread:

- 1/4" Gas
- 12 MA
- 12 MB

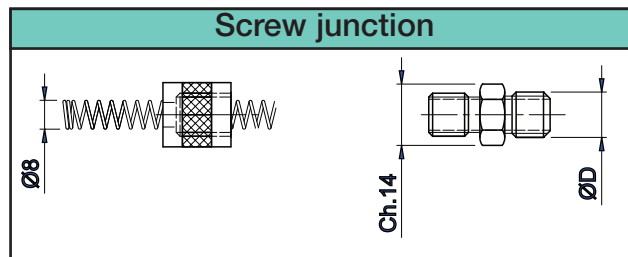

Available thread:

- 1/4" Gas
- 12 MA

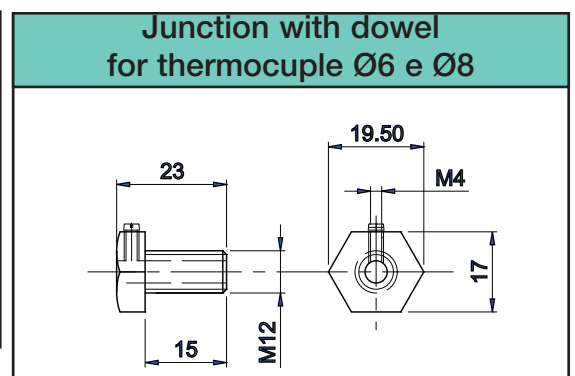
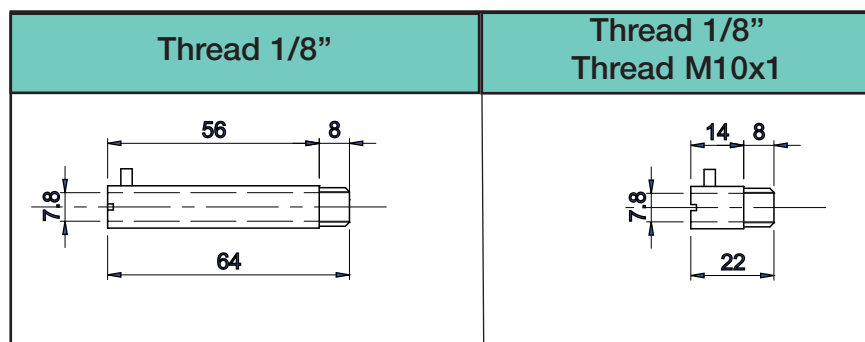
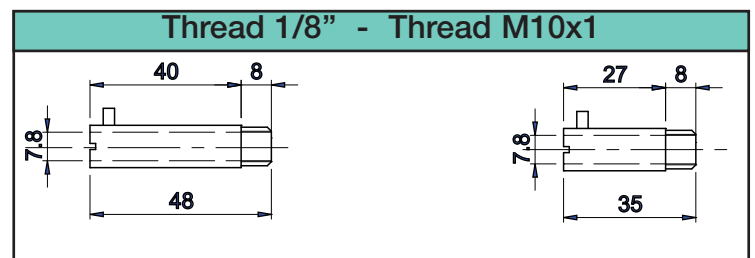
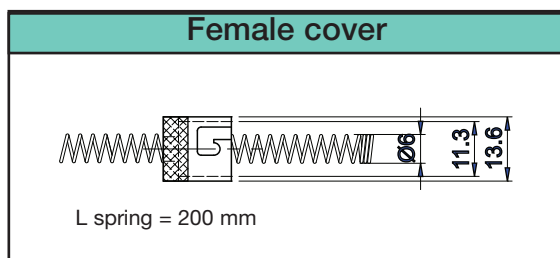

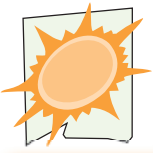

Technical features

Tolerance limits

ZRE thermocouples may be produced according to the following norm:

- UNI 7938
- ANSI MC96
- IEC 584

There are 2 precision classes:

- Class 1 (special)
- Class 2 (standard)

Following table shows tolerance limits for each thermocouple type.

	Class 1	Class 2
	special	standard
Thermocouple T	$0,5\text{ °C} \pm 0.004x[t]$	$1\text{ °C} \pm 0.0075x[t]$
	Temperature range in which the tolerance is valid	
	-40 .. +350°C	-40 .. +350°C
Thermocouple E J K	$1,5\text{ °C} \pm 0.004x [t]$	$2,5\text{ °C} \pm 0.0075x [t]$
	campo di temperatura della validità della tolleranza	
	-40 .. +800°C	-40 .. +800°C
	-40 .. +750°C	-40 .. +750°C
Thermocouple R / S B	$1\text{ °C} \pm [1 + 0.003(t-1100)]\text{ °C}$	$1,5\text{ °C} \pm 0.0025x[t]$
	Temperature range in which the tolerance is valid	
	0 .. +1600°C	0 .. +1600°C
	-	+600 .. 1700°C

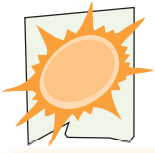

International thermocouples colour code

JIS 1610-1981 (Japan)							
NFE 18001 (France)							
BS1843 (U.K.-Czech republic)							
DIN43710 (Germany - Holland)							
ANSI (USA, Canada)							
IEC 584_3 (European)							
Temperature range ($^{\circ}\text{C}$)	-270/+400	-200/+760	-270/+1000	-270/+1372	-270/+1300	-50/1768	0/1820
	T Copper+ copper-nikel	J Iron + copper-nikel-	E nikel-chrome+ copper-nikel-	K nikel-chrome+ nikel-aluminium-	N nikel-chrome-silicon+ nikel-silicon-	SeR platinum-rhodium+ platinum-	B platinum30%-rhodium+ platinum-

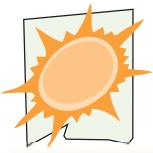

Model Z22 Resistance Temperature Detectors (RTD)

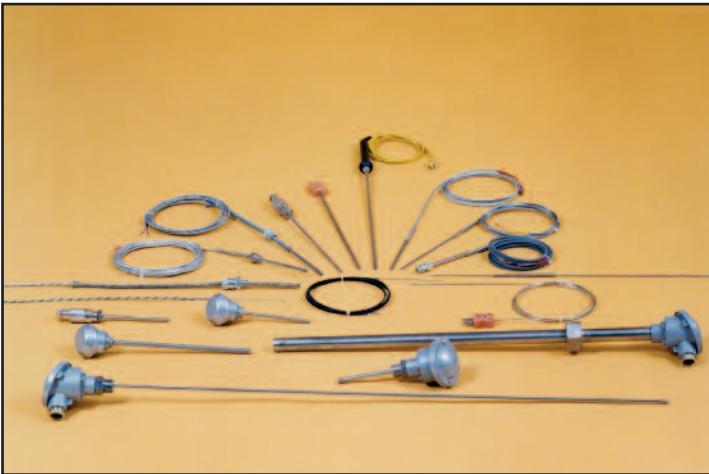

Technical features

General features

Resistance temperature detectors are temperature sensors that exploit the predictable change in electrical resistance of some materials with changing temperature. In industrial application they are almost invariably made of Platinum or Nickel whose features make them particularly suitable for manufacturing small sensors, very repeatable and high dynamic features,

Temperature sensors are usually identified by the material (Platinum=Pt, Nickel=Ni) followed by the nominal resistance value at 0°C. Standard configuration uses three wires

Wiring and way of measurement

RTDs require a small current (a fixed value) to be passed through in order to determine the resistance and at the same time a voltage drop control. Then temperature is deduced by Ohm's law.

There are three main wiring configurations:

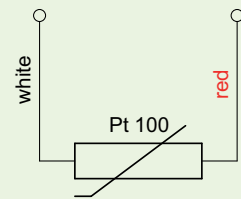

Two-wire configuration

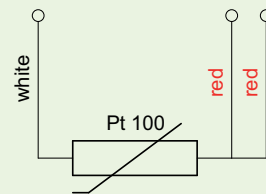

Three-wire configuration

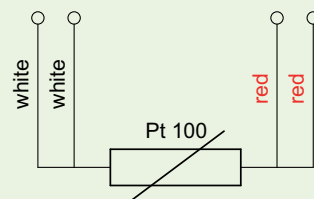

Four-wire configuration

How to order

- Model Z.22
- Application:
 - + Article number (if knows):
 - + Diameter:
 - + Length (L):
 - + Grounded or insulated:
 - + Cable length(LC):
 - + Cable type:
 - + Quantity:
 - + Any connection:

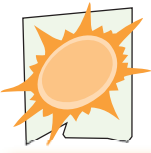

Technical features

Two-wire configuration:

The simplest resistance thermometer configuration uses two wires. It is only used when high accuracy is not required as the resistance of the connecting wires is always included with that of the sensor leading to errors in the signal. This applies equally to balanced bridge and fixed bridge system.

Three-wire configuration:

In order to minimize the effects of the lead resistances a three wire configuration can be used. This is the most common configuration in industrial application. Using this method the two leads to the sensor are on adjoining arms, there is a lead resistance in each arm of the bridge and therefore the lead resistance is cancelled out. High quality connection cables should be used for this type of configuration because an assumption is made that the two lead resistances are the same.

Four-wire configuration:

The four wire resistance thermometer configuration even further increases the accuracy and reliability of the resistance being measured. This is the configuration that guarantees the highest precision in temperature reading (Actually in four wire measurement the resistance error due to lead wire resistance is zero). It is mainly used for laboratory tests

Construction

Like for thermocouple two ways may be used to construct a RTD:

● MgO insulated

Those kind of thermocouples are made with Magnesium Oxide leads. Those leads are composed by a metallic external sheath in which the two metal conductors are insulated from each others and from the outer sheath with compressed MgO powder.

MgO insulated thermocouples are rugged sensors that guarantee much higher performance than those constructed using the classical method together with high shock resistance and vibrations resistance.

They can also be bent in order to adapt them to different application.

Response time, possibility of miniaturization and long lifespan are other particular characteristics of the mineral insulated sensors

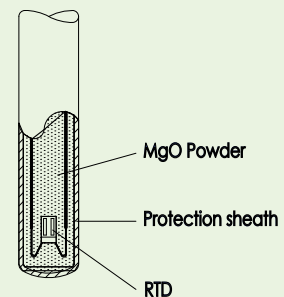

● With calibrated wires and insulators

The wires are insulated by an external rigid sheath using ceramic insulators

The outside sheath must provide suitable protection of the wires against gases or corrosive agents that may be present in the measurement environment.

Selection of the wires of suitable diameter and type according to the type of working environment is also important.

The suitable insulation (ceramic or fibreglass insulation) has to be identified according to the working temperature

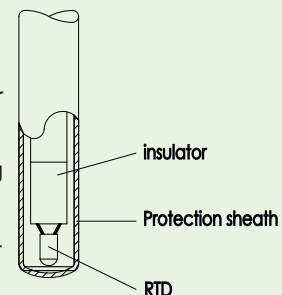

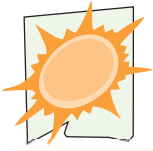

Compensated cables and connectors

Insulators	Working T°	Abrasion resistance	Flexibility	Impermeabl eness	Moisture resistance	Available for thermocou- ple	Available for RTD
Teflon/Teflon or Teflon/Teflon/electric shielding	--70..+250°C	Opitmum	Good	Opitmum	Opitmum	Yes	Yes
Silicone rubber / Silicone rubber or Silicone rubber / Silicone rubber / electric shielding	--50..+200°C	Medium	Good	Good	Good	Yes	Yes
Fibreglass / Fibreglass with fibreglass braided sleeve	--30..+400°C	Low	Good	Low	Low	Yes	Yes
Fibreglass / Fibreglass	--60..+400°C	Low	Good	Low	Low	Yes	No
Kapton/Kapton	--70..+400°C	Medium	Good	Good	Good	Yes	No

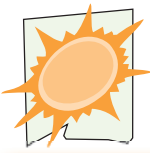

Standard male connector suitable for:

Type	Code
H	28SK1LB
J	24SJ1LB
S	33SS1LB
T	36ST1LB

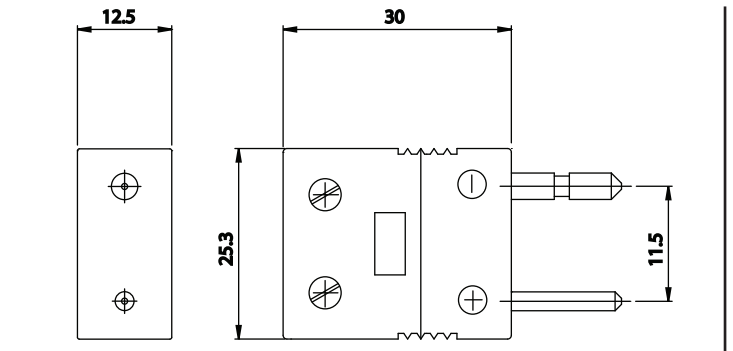

Standard movable female connector suitable for:

Type	Code
K	30SK2LB
J	25SJ2LB
S	34SS2LB
T	37ST2LB

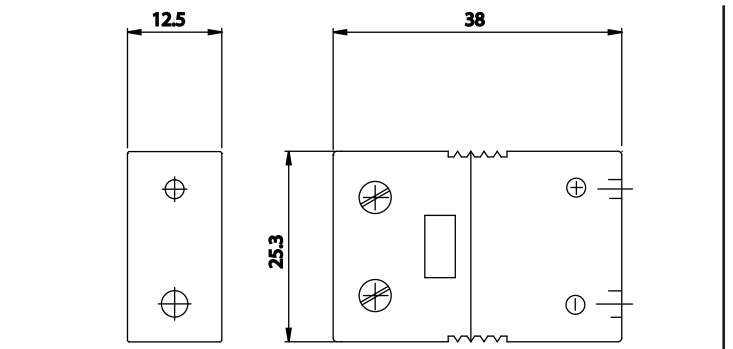

Standard female connector for panelboard (with template) suitable for:

Type	Code
K	32SK2LB
J	27SJ4LB
S	35SS4LB
T	39ST4LB

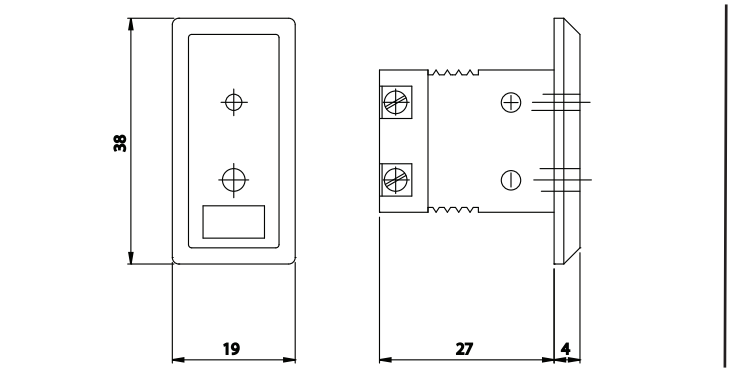

Miniature movable male connector suitable for:

Type	Code
K	12MK1LB
J	07MJ1LB
S	17MS1LB
T	21MT1LB

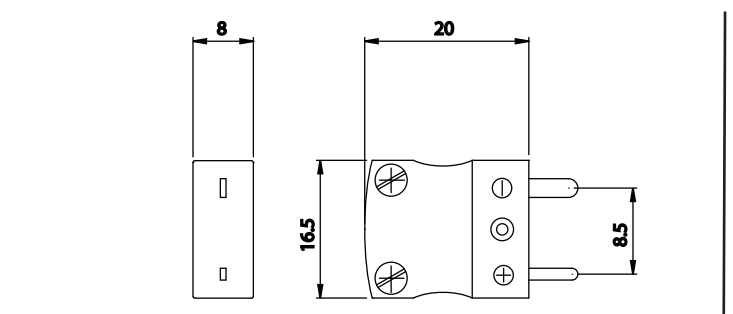

Miniature movable female connector suitable for:

Type	Code
K	13MK2LB
J	09MJ2LB
S	18MS2LB
T	22MT2LB

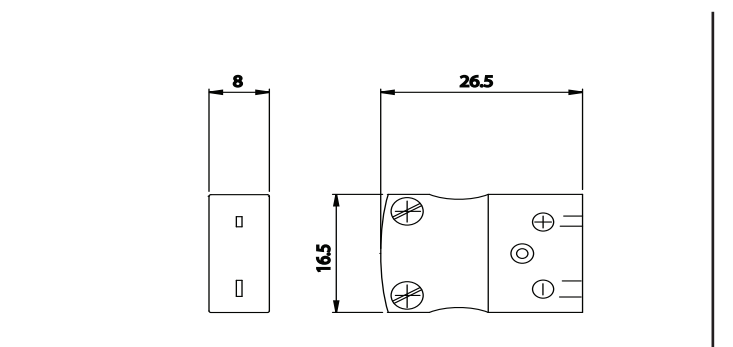

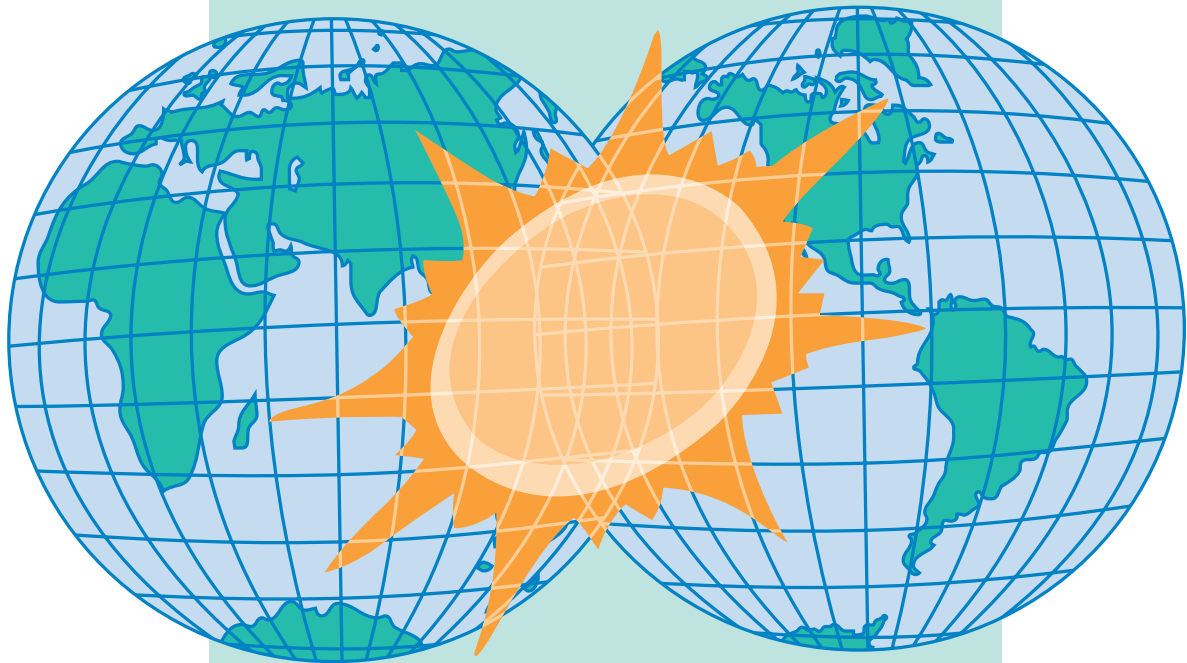

Z.R.E.[®] s.r.l.

10040 San Gillio - Torino (Italy) - Via Druento, 48/2
Tel. +390119841848 8 linee R.A. - Fax +390119848099
e-mail: info@zre.it www.zre.it

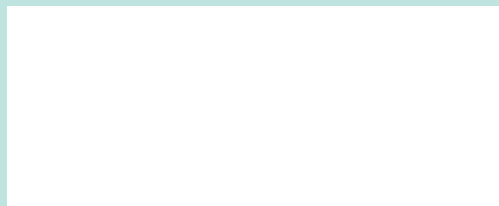

CE marking according to standard 2006/95/CE of 11/12/2006