









































<b>126</b>	PC2226 	PC2227 			PC2228 	PC2328 	<b>127</b>	
<b>128</b>	PC2230 	PC2231 			PC2259 	PC2233 	<b>129</b>	
<b>130</b>	PH1001 					PH1002 	<b>131</b>	
<b>132</b>	PC2234 	PC2248 			PC2229 	PC2247 	<b>133</b>	
<b>134</b>	PH1003 				PC2261 	PC2235 	<b>135</b>	
<b>136</b>	PC2237 	PC2232 				PC2263 	<b>137</b>	
<b>138</b>	PC2255 	PC2257 	PC2258 	PH1199 	PH1198 			
<b>140</b>	PC5102-04 	PC5111-12 			PC5110 	PC5101 	PC5121 	<b>141</b>
<b>142</b>	PC4601 	PC4651 			PC1051 	PC4351 	PC4701 	<b>143</b>
<b>144</b>	PC5910 	PC5901 	PC5902 		PC5801 	PC5802 	PC5803 	<b>145</b>

**PC2226** RACCORDO PORTAGOMMA OTTONE FILETTO MASCHIO BSPP  
BRASS HOSE TAIL WITH BSPP MALE THREAD



Raccordatura raccomandata - recommended clamping - p.140-141

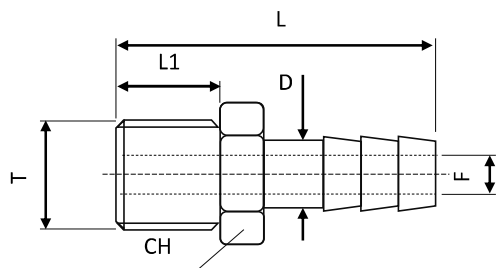

Codice-Code	CH	ØD tubo/hose	ØF	L	L1	T	🛒	
PC2226-06-M005	8	6	1/4"	4	22	4	M5	25
PC2226-06-M006	8	6	1/4"	4	22	4	M6	25
PC2226-06-G018	12	6	1/4"	4	29,5	6	G1/8"	10
PC2226-06-G014	14	6	1/4"	4	32	8	G1/4"	10
PC2226-08-G018	12	8	5/16"	5	29,5	6	G1/8"	25
PC2226-08-G014	14	8	5/16"	5	32	8	G1/4"	25
PC2226-08-G038	19	8	5/16"	5	33	9	G3/8"	25
PC2226-09-G018	12	9	5/14"	6	29,5	6	G1/8"	25
PC2226-09-G014	14	9	5/14"	6	32	8	G1/4"	25
PC2226-09-G038	19	9	5/14"	6	33	9	G3/8"	25
PC2226-10-G018	12	10	3/8"	7	30,5	6	G1/8"	10
PC2226-10-G014	14	10	3/8"	7	33	8	G1/4"	10
PC2226-10-G038	19	10	3/8"	7	34	9	G3/8"	10
PC2226-10-G012	22	10	3/8"	7	38	10	G1/2"	10
PC2226-12-G014	14	12	5/32"	8	33	8	G1/4"	25
PC2226-12-G038	19	12	5/32"	8	34	9	G3/8"	25
PC2226-12-G012	22	12	5/32"	8	35,5	10	G1/2"	25
PC2226-13-G014	15	13	1/2"	9	31	8	G1/4"	10
PC2226-13-G038	19	13	1/2"	9	37	9	G3/8"	10
PC2226-13-G012	22	13	1/2"	9	40	10	G1/2"	10
PC2226-16-G038	19	16	5/8"	11	52	12	G3/8"	10
PC2226-16-G012	23	16	5/8"	11	54	14	G1/2"	10
PC2226-16-G034	27	16	5/8"	11	58	14	G3/4"	10
PC2226-19-G012	22	19	3/4"	14	46	-	G1/2"	10
PC2226-19-G034	27	19	3/4"	14	49	-	G3/4"	10
PC2226-19-G100	36	19	3/4"	14	49	-	G1"	10

**PC2227** RACCORDO PORTAGOMMA OTTONE NICHELATO FILETTO MASCHIO BSPP O-R NBR  
NIKEL PLATED BRASS HOSE TAIL WITH BSPP MALE THREAD AND NBR O-RING

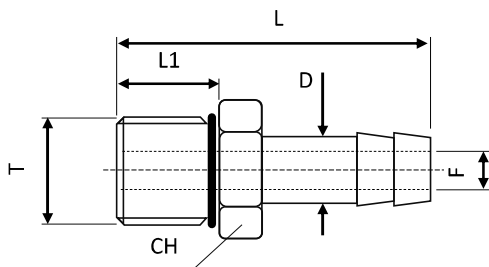

Raccordatura raccomandata - recommended clamping - p.140-141



Codice-Code	CH	ØD tubo/hose	ØF	L	L1	T	🛒	
PC2227-06-G018	14	6	1/4"	4	30	6,5	G1/8"	25
PC2227-06-G014	17	6	1/4"	4	32	8	G1/4"	25
PC2227-08-G018	14	8	5/16"	5	30	6,5	G1/8"	25
PC2227-08-G014	17	8	5/16"	5	32	8	G1/4"	25
PC2227-09-G018	14	9	5/14"	6	30	6,5	G1/8"	25
PC2227-09-G014	17	9	5/14"	6	32	8	G1/4"	25
PC2227-09-G038	20	9	5/14"	6	33	9	G3/8"	15
PC2227-12-G014	17	12	5/32"	8	33	8	G1/4"	25
PC2227-12-G038	20	12	5/32"	8	34	9	G3/8"	15
PC2227-12-G012	24	12	5/32"	8	35,5	10	G1/2"	15

**PC2228** RACCORDO PORTAGOMMA IN OTTONE NICHELATO FILETTO MASCHIO BSPT  
NIKEL PLATED HOSE TAIL WITH BSPT MALE THREAD

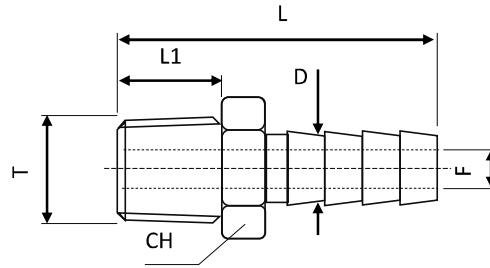

Codice-Code	CH	$\varnothing D$ tubo/hose	$\varnothing F$	L	L1	L2	T		
PC2228-06-R018	12	6 1/4"	4	31,5	8	-	R1/8"	25	
PC2228-06-R014	14	6 1/4"	4	35	11	-	R1/4"	25	
PC2228-08-R018	12	8 5/16"	5	31,5	8	-	R1/8"	25	
PC2228-08-R014	14	8 5/16"	5	35	11	-	R1/4"	25	
PC2228-09-R018	12	9 5/14"	6	31,5	8	-	R1/8"	25	
PC2228-09-R014	14	9 5/14"	6	35	11	-	R1/4"	25	
PC2228-09-R038	17	9 5/14"	6	35,5	12	-	R3/8"	15	
PC2228-09-R012	22	9 5/14"	6	38,5	14	-	R1/2"	15	
PC2228-10-R018	12	10 3/8"	7	32,5	8	-	R1/8"	25	
PC2228-10-R014	14	10 3/8"	7	36	11	-	R1/4"	25	
PC2228-10-R038	17	10 3/8"	7	36,5	12	-	R3/8"	15	
PC2228-12-R014	14	12 5/32"	8	36	11	-	R1/4"	25	
PC2228-12-R038	17	12 5/32"	8	36,5	12	-	R3/8"	15	
PC2228-12-R012	22	12 5/32"	8	39,5	14	-	R1/2"	15	
PC2228-16-R038	17	16 5/8"	11	38,5	12	-	R3/8"	15	
PC2228-16-R012	22	16 5/8"	11	41,5	14	-	R1/2"	15	
PC2228-16-R034	27	16 5/8"	11	45	17	-	R3/4"	10	
PC2228-20-R038	22	20	-	15	41	12	-	R3/8"	15
PC2228-20-R012	22	20	-	15	43,5	14	-	R1/2"	15
PC2228-20-R034	27	20	-	15	46,5	17	-	R3/4"	10

Raccordatura raccomandata - recommended clamping - p.140-141



**PC2328** RACCORDO PORTAGOMMA IN ACCIAIO INOX FILETTO MASCHIO BSPT  
STAINLESS STEEL HOSE TAIL WITH BSPT MALE THREAD

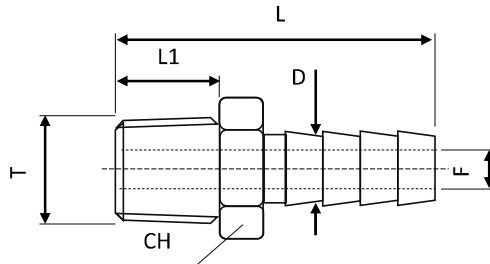

Codice-Code	CH	$\varnothing D$	$\varnothing D1$	L	L1	T	T1	max Bar	
PC2328-R018	12	6	4	34	9	R1/8"	-	20	10
PC2328-R014	14	8	5,5	36	10,5	R1/4"	-	20	10
PC2328-R038	17	10	8	42	11,5	R3/8"	-	20	10
PC2328-R012	22	14	11	51	15	R1/2"	-	20	10
PC2328-R034	27	20	14	65	18	R3/4"	-	20	10

Raccordatura raccomandata - recommended clamping - p.140-141



**PC2230** RACCORDO PORTAGOMMA IN OTTONE NICHELATO FIL. MASCHIO BSPP PROFILO EASY-LOCK  
NIKEL PLATED BRASS EASY LOCK HOSE TAIL WITH BSPP MALE THREAD

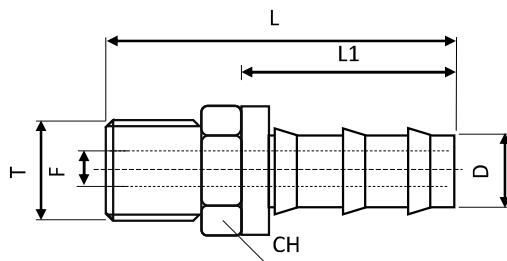

Codice-Code	CH	ØD tubo/hose	ØF	L	L1	L2	T	
PC2230-06-G018	13	6,3 1/4"	4	31,5	6,5	20	G1/8"	10
PC2230-06-G014	17	6,3 1/4"	4	35	8	20	G1/4"	10
PC2230-10-G014	17	9,5 3/8"	7,5	39,1	8	24,1	G1/4"	10
PC2230-10-G038	22	9,5 3/8"	7,5	42,5	9	24,1	G3/8"	10
PC2230-13-G038	22	13 1/2"	10	46,5	9	28	G3/8"	10
PC2230-13-G012	27	13 1/2"	10	48,5	10	28	G1/2"	10
PC2230-16-G012	27	16 5/8"	14	56,5	10	36,5	G1/2"	10
PC2230-16-G034	32	16 5/8"	14	58,5	11	36,5	G3/4"	10
PC2230-19-G034	32	19 3/4"	16	65,3	11	43	G3/4"	10

**PC2231** RACCORDO PORTAGOMMA IN OTTONE NICHELATO FILETTO FEMINA BSPP  
NIKEL PLATED HOSE TAIL WITH BSPP FEMALE THREAD

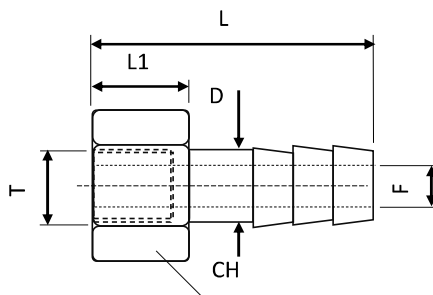

Codice-Code	CH	ØD tubo/hose	ØF	L	L1	L2	T	
PC2231-06-G018	11	6 1/4"	4	27	10	-	G1/8"	25
PC2231-06-G014	17	6 1/4"	4	33	13	-	G1/4"	25
PC2231-08-G018	12	8 5/16"	5	27	10	-	G1/8"	25
PC2231-08-G014	17	8 5/16"	5	33	13	-	G1/4"	25
PC2231-09-G018	12	9 5/14"	6	27	10	-	G1/8"	20
PC2231-09-G014	17	9 5/14"	6	33	13	-	G1/4"	20
PC2231-10-G014	17	10 3/8"	7	36	-	-	G1/4"	20
PC2231-10-G038	19	10 3/8"	7	36	-	-	G3/8"	15
PC2231-10-G012	24	10 3/8"	7	39	-	-	G1/2"	15
PC2231-13-G014	17	13 1/2"	7	36	-	-	G1/4"	15
PC2231-13-G038	19	13 1/2"	7	36	-	-	G3/8"	15
PC2231-13-G012	24	13 1/2"	7	39	-	-	G1/2"	15
PC2231-16-G012	24	16 5/8"	12	43	-	-	G1/2"	10

Raccordatura raccomandata - recommended clamping - p.140-141



**PC2259** PORTAGOMMA IN ACCIAIO ZINCATO FILETTO FEMMINA BSPP GIREVOLE  
GALVANIZED STEEL SWIVEL HOSE TAIL WITH BSPP FEMALE THREAD

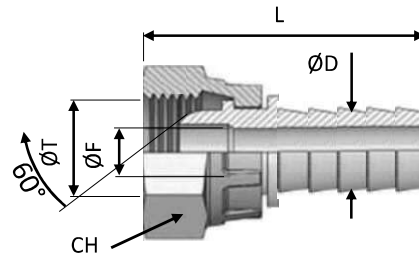

Codice-Code	CH	ØD tubo/hose	ØF	L	L1	L2	T	🛒	
PC2259-06-G018	-	6.3	1/4"	3,5	-	-	-	G1/8"	5
PC2259-06-G014	-	6,3	1/4"	5	-	-	-	G1/4"	5
PC2259-08-G014	-	8	5/16"	6	-	-	-	G1/4"	5
PC2259-10-G014	-	9,5	3/8"	7,5	-	-	-	G1/4"	5
PC2259-10-G038	-	9,5	3/8"	7,5	-	-	-	G3/8"	5
PC2259-13-G038	-	13	1/2"	9	-	-	-	G3/8"	5
PC2259-13-G012	-	13	1/2"	9	-	-	-	G1/2"	5
PC2259-16-G012	-	16	5/8"	11	-	-	-	G1/2"	5
PC2259-16-G034	-	16	5/8"	11	-	-	-	G3/4"	5
PC2259-19-G034	-	19	3/4"	13	-	-	-	G3/4"	5
PC2259-19-G100	-	19	3/4"	15	-	-	-	G1"	5

Raccordatura raccomandata – recommended clamping – p.140-141



**PC2233** PORTAGOMMA IN ACCIAIO ZINCATO PROFILO EASY-LOCK FIL. FEMMINA BSPP GIREVOLE  
GALVANIZED STEEL EASY-LOCK HOSE TAIL WITH SWIVEL BSPP FEMALE THREAD

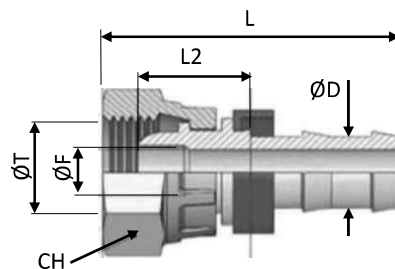

Codice-Code	CH	ØD tubo/hose	ØF	L	L1	L2	T	🛒	
PC2233-06-M014	19	6,3	1/8"	4	37,2	18	13,2	M14x1,5	5
PC2233-06-M016	20	9,5	3/8"	7	44,3	22	14,2	M16x1,5	5
PC2233-06-G014	19	6,3	1/8"	4	37,2	18	13,2	G1/4"	5
PC2233-10-M016	20	9,5	3/8"	7	44,3	22	14,2	M16x1,5	5
PC2233-10-M018	20	9,5	3/8"	7	44,3	22	14,2	M18x1,5	5
PC2233-10-G038	20	9,5	3/8"	7	44,3	22	14,2	G3/8"	5
PC2233-13-M022	27	13	1/2"	9,5	51,5	29	22,5	M22x1,5	5
PC2233-13-G012	27	13	1/2"	9,5	51,5	29	22,5	G1/2"	5
PC2233-16-M022	27	16	5/16"	15	68,2	39	22,5	M22x1,5	5
PC2233-16-M026	32	16	5/16"	15	68,2	39	27,6	M26x1,5	5
PC2233-19-M030	32	19	3/4"	15	68,2	39	27,6	M30x1,5	5
PC2233-19-G034	32	19	3/4"	15	68,2	39	27,6	G3/4"	5
PC2233-25-G100	41	25	1"	20	74	39	28,4	G1"	5

**PH1001** PORTAGOMMA IN ACCIAIO ZINCATO PER TUBI ALTA PRESSIONE FIL. FEMMINA BSPP GIREVOLE  
GALVANIZED STEEL HOSE TAIL WITH SWIVEL BSPP FEMALE THREAD FOR HIGH PRESSURE HOSES

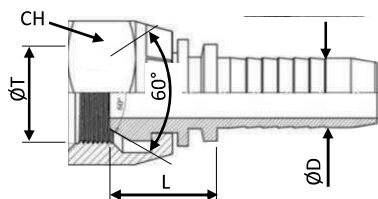

Raccordatura raccomandata –  
recommended clamping – p. 142, 143



Codice-Code	CH	ØD tubo/hose	L	L1	ØT	max bar	
PH1001-014-M012	14	1/4"	15,5	-	M12x1,5	350	10
PH1001-014-M014	19	1/4"	15,5	-	M14x1,5	350	10
PH1001-014-M016	19	1/4"	17,5	-	M16x1,5	350	10
PH1001-014-G018	14	1/4"	15,5	-	G 1/8"	350	10
PH1001-014-G014	19	1/4"	15,5	-	G 1/4"	350	10
PH1001-014-G038	22	1/4"	17,5	-	G 3/8"	350	10
PH1001-038-M016	22	3/8"	18	-	M16x1,5	350	10
PH1001-038-M018	22	3/8"	18	-	M18x1,5	350	10
PH1001-038-M020	27	3/8"	19	-	M20x1,5	350	10
PH1001-038-G014	19	3/8"	16	-	G 1/4"	350	10
PH1001-038-G038	22	3/8"	18	-	G 3/8"	350	10
PH1001-038-G012	27	3/8"	19	-	G 1/2"	315	10
PH1001-012-M018	22	1/2"	18	-	M18x1,5	315	5
PH1001-012-M022	27	1/2"	19	-	M22x1,5	315	5
PH1001-012-M026	32	1/2"	21,5	-	M26x1,5	315	5
PH1001-012-G038	27	1/2"	19	-	G 3/8"	315	5
PH1001-012-G012	22	1/2"	18	-	G 1/2"	350	5
PH1001-012-G034	32	1/2"	21,5	-	3/4"	250	5
PH1001-034-M026	32	3/4"	22,5	-	M26x1,5	250	1
PH1001-034-G034	32	3/4"	22,5	-	3/4"	250	1
PH1001-034-G100	41	3/4"	23,5	-	1"	200	1
PH1001-100-G100	41	1"	24	-	1"	200	1

**PH1001** PORTAGOMMA IN ACCIAIO INOX PER TUBI ALTA PRESSIONE FIL. FEMMINA BSPP GIREVOLE  
STAINLESS STEEL HOSE TAIL WITH SWIVEL BSPP FEMALE THREAD FOR HIGH PRESSURE HOSES

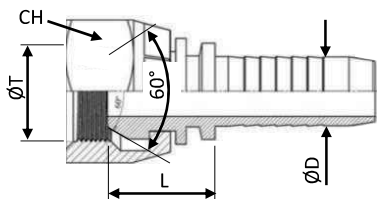

Raccordatura raccomandata –  
recommended clamping – p. 142, 143



Codice-Code	CH	ØD tubo/hose	L	L1	ØT	max bar	
PH1001-014-M012-S	14	1/4"	15,5	-	M12x1,5	350	10
PH1001-014-M014-S	19	1/4"	15,5	-	M14x1,5	350	10
PH1001-014-M016-S	19	1/4"	17,5	-	M16x1,5	350	10
PH1001-014-G018-S	14	1/4"	15,5	-	G 1/8"	350	10
PH1001-014-G014-S	19	1/4"	15,5	-	G 1/4"	350	10
PH1001-014-G038-S	22	1/4"	17,5	-	G 3/8"	350	10
PH1001-038-M016-S	22	3/8"	18	-	M16x1,5	350	10
PH1001-038-M018-S	22	3/8"	18	-	M18x1,5	350	10
PH1001-038-M020-S	27	3/8"	19	-	M20x1,5	350	10
PH1001-038-G014-S	19	3/8"	16	-	G 1/4"	350	10
PH1001-038-G038-S	22	3/8"	18	-	G 3/8"	350	10
PH1001-038-G012-S	27	3/8"	19	-	G 1/2"	315	10
PH1001-012-M018-S	22	1/2"	18	-	M18x1,5	315	5
PH1001-012-M022-S	27	1/2"	19	-	M22x1,5	315	5
PH1001-012-M026-S	32	1/2"	21,5	-	M26x1,5	315	5
PH1001-012-G038-S	27	1/2"	19	-	G 3/8"	315	5
PH1001-012-G012-S	22	1/2"	18	-	G 1/2"	350	5
PH1001-012-G034-S	32	1/2"	21,5	-	3/4"	250	5
PH1001-034-M026-S	32	3/4"	22,5	-	M26x1,5	250	1
PH1001-034-G034-S	32	3/4"	22,5	-	3/4"	250	1
PH1001-034-G100-S	41	3/4"	23,5	-	1"	200	1
PH1001-100-G100-S	41	1"	24	-	1"	200	1

**PH1002 PORTAGOMMA IN ACCIAIO ZINCATO 45° PER TUBI ALTA PRESSIONE FIL. FEMMINA BSPP GIREVOLE**  
**GALVANIZED STEEL HOSE TAIL 45° WITH SWIVEL BSPP FEMALE THREAD FOR HIGH PRESSURE HOSES**

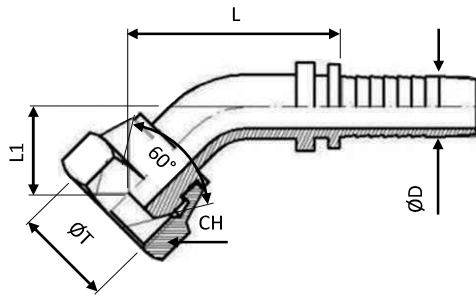

Raccordatura raccomandata -  
recommended clamping - p. 142, 143



Codice-Code	CH	ØD tubo/hose	L	L1	max bar	ØT	
PH1002-014-M012	14	1/4"	37	13,5	350	M12x1,5	10
PH1002-014-M014	19	1/4"	37,5	14	350	M14x1,5	10
PH1002-014-M016	19	1/4"	40,5	17,5	350	M16x1,5	10
PH1002-014-G018	14	1/4"	37	13,5	350	G 1/8"	10
PH1002-014-G014	19	1/4"	37,5	14	350	G 1/4"	10
PH1002-014-G038	22	1/4"	40,5	17,5	350	G 3/8"	10
PH1002-038-M016	22	3/8"	51,5	19	350	M16x1,5	10
PH1002-038-M018	22	3/8"	51,5	19	350	M18x1,5	10
PH1002-038-M020	27	3/8"	53,5	21	350	M20x1,5	10
PH1002-038-G014	19	3/8"	50	17,5	350	G 1/4"	10
PH1002-038-G038	22	3/8"	51,5	19	350	G 3/8"	10
PH1002-038-G012	27	3/8"	53,5	21	315	G 1/2"	10
PH1002-012-M018	22	1/2"	60,5	20,5	315	M18x1,5	5
PH1002-012-M022	27	1/2"	61	21	315	M22x1,5	5
PH1002-012-M026	32	1/2"	65,5	25,5	315	M26x1,5	5
PH1002-012-G038	22	1/2"	60,5	20,5	350	G 3/8"	5
PH1002-012-G012	27	1/2"	61	21	315	G 1/2"	5
PH1002-012-G034	32	1/2"	65,5	25,5	250	3/4"	5
PH1002-034-M026	32	3/4"	81	26	250	M26x1,5	1
PH1002-034-G034	32	3/4"	81	26	250	3/4"	1
PH1002-034-G100	41	3/4"	83,5	28,5	200	1"	1
PH1002-100-G100	41	1"	99,5	29	200	1"	1

**PH1002 PORTAGOMMA 45° IN ACCIAIO INOX PER TUBI ALTA PRESSIONE FIL. FEMMINA BSPP GIREVOLE**  
**45° STAINLESS STEEL HOSE TAIL WITH SWIVEL BSPP FEMALE THREAD FOR HIGH PRESSURE HOSES**

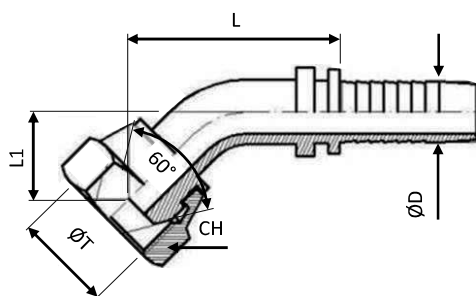

Raccordatura raccomandata -  
recommended clamping - p. 142, 143



Codice-Code	CH	ØD tubo/hose	L	L1	max bar	ØT	
PH1002-014-M012-S	14	1/4"	37	13,5	350	M12x1,5	10
PH1002-014-M014-S	19	1/4"	37,5	14	350	M14x1,5	10
PH1002-014-M016-S	19	1/4"	40,5	17,5	350	M16x1,5	10
PH1002-014-G018-S	14	1/4"	37	13,5	350	G 1/8"	10
PH1002-014-G014-S	19	1/4"	37,5	14	350	G 1/4"	10
PH1002-014-G038-S	22	1/4"	40,5	17,5	350	G 3/8"	10
PH1002-038-M016-S	22	3/8"	51,5	19	350	M16x1,5	10
PH1002-038-M018-S	22	3/8"	51,5	19	350	M18x1,5	10
PH1002-038-M020-S	27	3/8"	53,5	21	350	M20x1,5	10
PH1002-038-G014-S	19	3/8"	50	17,5	350	G 1/4"	10
PH1002-038-G038-S	22	3/8"	51,5	19	350	G 3/8"	10
PH1002-038-G012-S	27	3/8"	53,5	21	315	G 1/2"	10
PH1002-012-M018-S	22	1/2"	60,5	20,5	315	M18x1,5	5
PH1002-012-M022-S	27	1/2"	61	21	315	M22x1,5	5
PH1002-012-M026-S	32	1/2"	65,5	25,5	315	M26x1,5	5
PH1002-012-G038-S	22	1/2"	60,5	20,5	350	G 3/8"	5
PH1002-012-G012-S	27	1/2"	61	21	315	G 1/2"	5
PH1002-012-G034-S	32	1/2"	65,5	25,5	250	3/4"	5
PH1002-034-M026-S	32	3/4"	81	26	250	M26x1,5	1
PH1002-034-G034-S	32	3/4"	81	26	250	3/4"	1
PH1002-034-G100-S	41	3/4"	83,5	28,5	200	1"	1
PH1002-100-G100-S	41	1"	99,5	29	200	1"	1

**PC2234** PORTAGOMMA IN ACCIAIO ZINCATO 45° PROFILO EASY-LOCK FIL. FEMMINA BSPP GIREVOLE  
GALVANIZED STEEL EASY-LOCK HOSE TAIL 45° WITH SWIVEL BSPP FEMALE THREAD

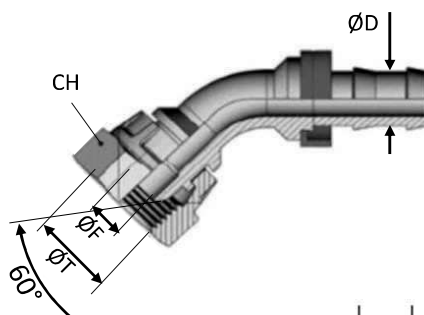

Codice-Code	CH	ØD tubo/hose	ØF	L	T	max bar	
PC2234-06-M014	19	6,3	1/8"	4	-	M14x1,5	5
PC2234-06-M016	20	9,5	3/8"	7	-	M16x1,5	5
PC2234-06-G014	19	6,3	1/4"	4	-	G1/4"	5
PC2234-10-M016	20	9,5	3/8"	7	-	M16x1,5	5
PC2234-10-M018	20	9,5	3/8"	7	-	M18x1,5	5
PC2234-10-G038	22	9,5	3/8"	7	-	G3/8"	5
PC2234-13-M022	27	12,7	1/2"	9,5	-	M22x1,5	5
PC2234-13-G012	27	12,7	1/2"	9,5	-	G1/2"	5
PC2234-16-M026	32	16	5/16"	14,5	-	M26x1,5	5
PC2234-19-G034	32	19,1	3/4"	14,5	-	G3/4"	5
PC2234-19-M030	32	19,1	3/4"	14,5	-	M30x1,5	5
PC2234-25-G100	46	25	1"	20	-	G1"	5

**PC2248** RACCORDO IN OTTONE NICHELATO PORTAGOMMA 90° FILETTO MASCHIO BSPP ED O-RING NBR  
NIKEL PLATED BRASS HOSE TAIL WITH 90° BSPP MALE THREAD WITH NBR O-RING

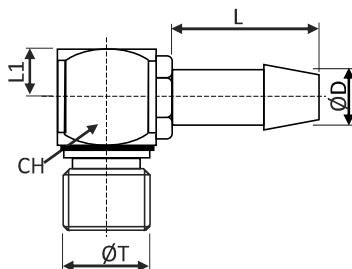

Codice-Code	CH	ØD tubo/hose	ØF	L	L1	T	
PC2248-08-G014	20	8	-	26	10	G1/4"	5
PC2248-10-G014	20	10	3/8"	28	10	G1/4"	5
PC2248-10-G038	20	10	3/8"	28	10	G3/8"	5
PC2248-12-G038	20	12	-	30	10	G3/8"	5
PC2248-13-G012	25	13	1/2"	32	12,5	G1/2"	1
PC2248-16-G012	25	15,9	5/8"	34	12,5	G1/2"	1

Raccordatura raccomandata - recommended clamping - p.140-141





**PC2229** RACCORDO IN OTTONE PORTAGOMMA 90° FILETTO MASCHIO BSPT  
BRASS HOSE TAIL WITH 90° BSP MALE THREAD

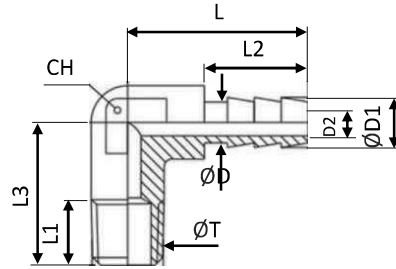

Codice-Code	CH	ØD tubo/hose	ØF	L	L1	L2	T	
PC2229-06-R018	8	6 1/4"	4	22,5	11	14	R1/8"	20
PC2229-06-R014	9	6 1/4"	4	23	11	14	R1/4"	20

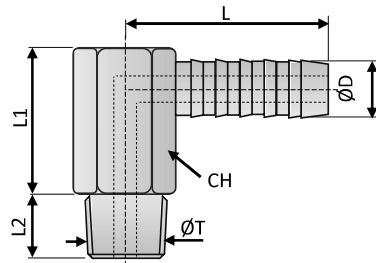

Codice-Code	CH	ØD tubo/hose	ØF	L	L1	L2	T	
PC2229-09-M008	11	9 3/8"	5	23	27	9	M8x0,75	10
PC2229-09-M010	11	9 3/8"	6	23	27	9	M10x1	10
PC2229-09-R018	11	9 3/8"	6	23	27	9	R1/8"	10
PC2229-13-M014	15	13 1/2"	11	32,5	34	12	M14x1,5	10
PC2229-13-R014	15	13 1/2"	10	32,5	34	12	R1/4"	10
PC2229-19-M024	24	19 3/4"	14	44	47	16	M24x1,5	5
PC2229-19-R012	22	19 3/4"	14	44	47	16	R1/2"	5

Raccordatura raccomandata - recommended clamping - p.140-141



**PC2247** RACCORDO IN OTTONE NICHELATO EASY LOCK 90° FILETTO MASCHIO BSPP ED O-RING NBR  
NICKEL PLATED BRASS EASY LOCK TAIL WITH 90° BSPP MALE THREAD WITH NBR O-RING

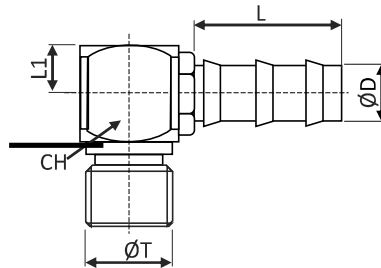

Codice-Code	CH	ØD tubo/hose	ØF	L	L1	L2	T	
PC2247-10-G014	20	10 3/8"	-	25	10	-	G1/4"	5
PC2247-10-G038	20	10 3/8"	-	25	10	-	G3/8"	5
PC2247-13-G038	20	13 1/2"	-	25	10	-	G3/8"	5
PC2247-13-G012	25	13 1/2"	-	32	13	-	G1/2"	1
PC2247-16-G012	25	16 5/8"	-	35	13	-	G1/2"	1

**PH1003** PORTAGOMMA IN ACCIAIO ZINCATO 90° PER TUBI ALTA PRESSIONE FIL. FEMMINA BSPP GIREVOLE  
GALVANIZED STEEL HOSE TAIL 90° WITH SWIVEL BSPP FEMALE THREAD FOR HIGH PRESSURE HOSES

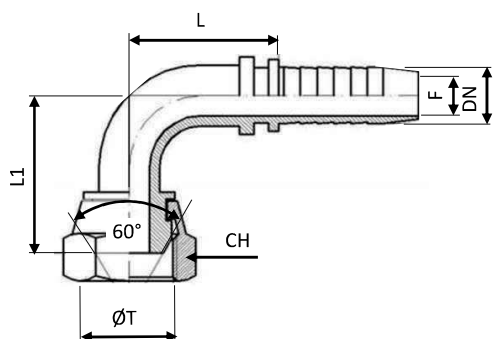

Raccordatura raccomandata -  
recommended clamping - p. 142, 143



Codice-Code	CH	ØD tubo/hose	L	L1	ØT	max bar	
PH1003-014-M012	14	6,3 1/4"	21	26,5	M12x1,5	350	10
PH1003-014-M014	19	6,3 1/4"	21	26,5	M14x1,5	350	10
PH1003-014-M016	19	6,3 1/4"	21	30,5	M16x1,5	350	10
PH1003-014-G018	14	6,3 1/4"	21	26,5	G 1/8"	350	10
PH1003-014-G014	19	6,3 1/4"	21	26,5	G 1/4"	350	10
PH1003-014-G038	22	6,3 1/4"	21	30,5	G 3/8"	350	10
PH1003-038-M016	22	9,5 3/8"	29	36,5	M16x1,5	350	10
PH1003-038-M018	22	9,5 3/8"	29	36,5	M18x1,5	350	10
PH1003-038-M020	27	9,5 3/8"	29	39,5	M20x1,5	350	10
PH1003-038-G014	19	9,5 3/8"	29	34,5	G 1/4"	350	10
PH1003-038-G038	22	9,5 3/8"	29	36,5	G 3/8"	350	10
PH1003-038-G012	27	9,5 3/8"	29	39,5	G 1/2"	315	10
PH1003-012-M018	22	12,7 1/2"	35,5	40,5	M18x1,5	315	10
PH1003-012-M022	27	12,7 1/2"	35,5	41,5	M22x1,5	315	10
PH1003-012-M026	32	12,7 1/2"	35,5	47,5	M26x1,5	315	10
PH1003-012-G038	22	12,7 1/2"	35,5	40,5	G 3/8"	350	5
PH1003-012-G012	27	12,7 1/2"	35,5	41,5	G 1/2"	315	5
PH1003-012-G034	32	12,7 1/2"	35,5	47,5	3/4"	250	5
PH1001-034-M026	32	19 3/4"	49,5	52,5	M26x1,5	250	1
PH1003-034-G034	32	19 3/4"	49,5	52,5	3/4"	250	1
PH1003-034-G100	41	19 3/4"	50	56	1"	200	1
PH1003-100-G100	41	25 1"	63	62	1"	200	1

**PH1003** PORTAGOMMA A 90° IN ACCIAIO INOX PER TUBI ALTA PRESSIONE FIL. FEMMINA BSPP GIREVOLE  
90° STAINLESS STEEL HOSE TAIL WITH SWIVEL BSPP FEMALE THREAD FOR HIGH PRESSURE HOSES

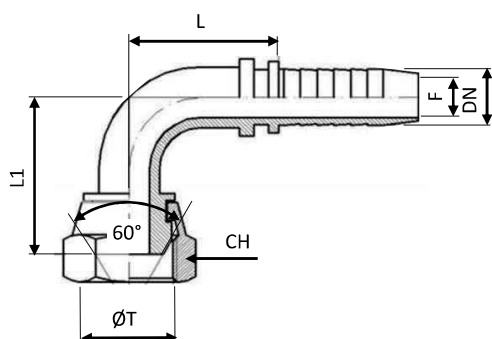

Raccordatura raccomandata -  
recommended clamping - p. 142, 143



Codice-Code	CH	ØD tubo/hose	L	L1	ØT	max bar	
PH1003-014-M012-S	14	6,3 1/4"	21	26,5	M12x1,5	350	10
PH1003-014-M014-S	19	6,3 1/4"	21	26,5	M14x1,5	350	10
PH1003-014-M016-S	19	6,3 1/4"	21	30,5	M16x1,5	350	10
PH1003-014-G018-S	14	6,3 1/4"	21	26,5	G 1/8"	350	10
PH1003-014-G014-S	19	6,3 1/4"	21	26,5	G 1/4"	350	10
PH1003-014-G038-S	22	6,3 1/4"	21	30,5	G 3/8"	350	10
PH1003-038-M016-S	22	9,5 3/8"	29	36,5	M16x1,5	350	10
PH1003-038-M018-S	22	9,5 3/8"	29	36,5	M18x1,5	350	10
PH1003-038-M020-S	27	9,5 3/8"	29	39,5	M20x1,5	350	10
PH1003-038-G014-S	19	9,5 3/8"	29	34,5	G 1/4"	350	10
PH1003-038-G038-S	22	9,5 3/8"	29	36,5	G 3/8"	350	10
PH1003-038-G012-S	27	9,5 3/8"	29	39,5	G 1/2"	315	10
PH1003-012-M018-S	22	12,7 1/2"	35,5	40,5	M18x1,5	315	10
PH1003-012-M022-S	27	12,7 1/2"	35,5	41,5	M22x1,5	315	10
PH1003-012-M026-S	32	12,7 1/2"	35,5	47,5	M26x1,5	315	10
PH1003-012-G038-S	22	12,7 1/2"	35,5	40,5	G 3/8"	350	5
PH1003-012-G012-S	27	12,7 1/2"	35,5	41,5	G 1/2"	315	5
PH1003-012-G034-S	32	12,7 1/2"	35,5	47,5	3/4"	250	5
PH1001-034-M026-S	32	19 3/4"	49,5	52,5	M26x1,5	250	1
PH1003-034-G034-S	32	19 3/4"	49,5	52,5	3/4"	250	1
PH1003-034-G100-S	41	19 3/4"	50	56	1"	200	1
PH1003-100-G100-S	41	25 1"	63	62	1"	200	1

**PC2261** PORTAGOMMA FIL. FEMMINA BSPP GIREVOLE 90° - ACCIAIO ZINCATO  
SWIVEL BSPP FEMALE THREAD HOSE TAIL 90° - GALVANIZED STEEL

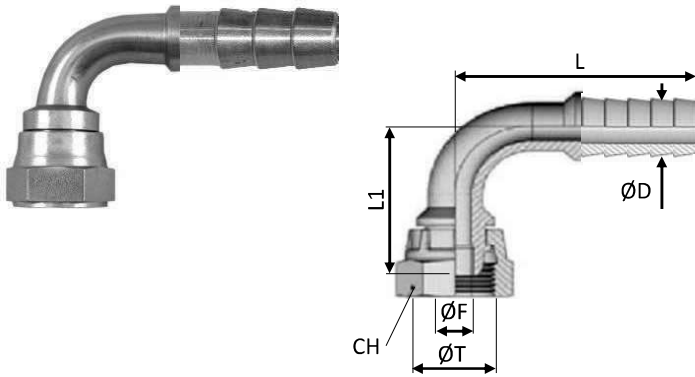

Codice-Code	CH	ØD		ØF	L	L1	T	max bar	
		tubo/hose							
PC2261-06-G018	-	6,3	1/4"	5	-	-	G1/8"	25	5
PC2261-06-G014	-	6,3	1/4"	5	-	-	G1/4"	25	5
PC2261-08-G014	-	8	5/16"	6	-	-	G1/4"	25	5
PC2261-10-G014	19	9,5	3/8"	7,5	40	35	G1/4"	25	5
PC2261-10-G038	22	9,5	3/8"	7,5	50	43	G3/8"	25	5
PC2261-13-G038	22	12,7	1/2"	9	51	41	G3/8"	25	5
PC2261-13-G012	27	12,7	1/2"	9	55	43	G1/2"	20	5
PC2261-16-G012	-	16	5/8"	11	-	-	G1/2"	15	5
PC2261-19-G034	-	19	3/4"	13	-	-	G3/4"	15	5

Raccordatura raccomandata - recommended clamping - p.140-141



**PC2235** PORTAGOMMA EASY-LOCK FIL. FEMMINA BSPP GIREVOLE 90° - ACCIAIO ZINCATO  
SWIVEL BSPP FEMALE THREAD EASY-LOCK HOSE TAIL 90° - GALVANIZED STEEL

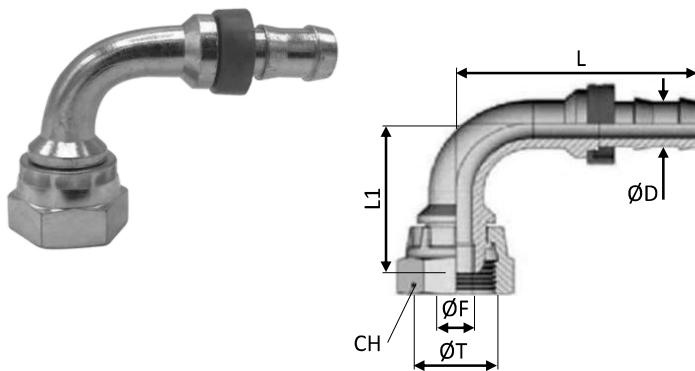

Codice-Code	CH	ØD		ØF	L	L1	T	max bar	
		tubo/hose							
PC2235-06-M014	19	6,3	1/4"	4	19	25	M14x1,5	25	5
PC2235-06-M016	22	6,3	1/4"	4	19	-	M16x1,5	25	5
PC2235-06-G014	19	6,3	1/4"	4	19	25	G1/4"	25	5
PC2235-10-M016	20	9,5	3/8"	7	22	-	M16x1,5	25	5
PC2235-10-M018	20	9,5	3/8"	7	22	-	M18x1,5	25	5
PC2235-10-G038	22	9,5	3/8"	7	22	35	G3/8"	25	5
PC2235-13-M022	27	12,7	1/2"	9,5	27	42	M22x1,5	25	5
PC2235-13-G012	27	12,7	1/2"	9,5	27	42	G1/2"	25	5
PC2235-16-M026	32	16	5/16"	14,5	29	61	M26x1,5	25	5
PC2235-19-M030	32	19,1	3/4"	14,5	32	-	M30x1,5	25	5
PC2235-19-G034	32	19,1	3/4"	14,5	32	58	G3/4"	25	5
PC2235-25-G100	40	25	1"	20	40	-	G1"	20	5

**PC2237** PORTAGOMMA OTTONE FILETTO MASCHIO BSPT PROLUNGATO  
BRASS HOSE STEM TUBE WITH BSPT MALE THREAD

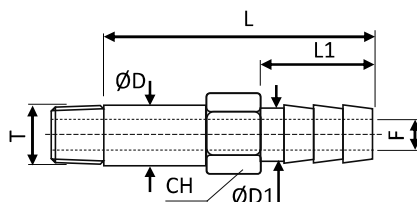
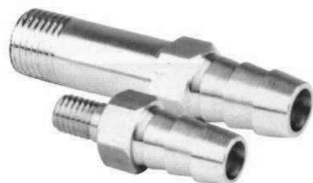

Codice-Code	CH	ØD	ØF	L	L1	T	max bar	
PC2237-09-R018-L038	11	9	6	38	-	R 1/8"	15	5
PC2237-09-R018-L060	11	9	6	60	-	R 1/8"	15	5
PC2237-09-R018-L080	11	9	6	80	-	R 1/8"	15	5
PC2237-09-R018-L100	11	9	6	100	-	R 1/8"	15	5
PC2237-09-R018-L120	11	9	6	120	-	R 1/8"	15	5
PC2237-09-R018-L150	11	9	6	150	-	R 1/8"	15	5
PC2237-13-R014-L038	15	13	9	38	-	R 1/4"	12	5
PC2237-13-R014-L060	15	13	9	60	-	R 1/4"	12	5
PC2237-13-R014-L080	15	13	9	80	-	R 1/4"	12	5
PC2237-13-R014-L100	15	13	9	100	-	R 1/4"	12	5
PC2237-13-R014-L120	15	13	9	120	-	R 1/4"	12	5
PC2237-13-R014-L150	15	13	9	150	-	R 1/4"	12	5

Raccordatura raccomandata - recommended clamping - p.140-141



**PC2232** PROLUNGA LISCIA IN OTTONE CON PORTAGOMMA  
BRASS SMOOTH EXTENSION WITH HOSE TAIL

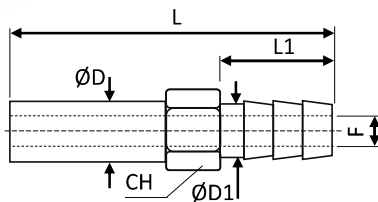

Codice-Code	CH	ØD	F	L	L1	L2	T	
PC2232-09-10-L120	11	10	-	120	25	-	-	4
PC2232-09-10-L240	11	10	-	240	25	-	-	1
PC2232-09-10-L360	11	10	-	360	25	-	-	1
PC2232-13-14-L150	15	10	-	150	33	-	-	4
PC2232-13-14-L300	15	14	-	300	33	-	-	1
PC2232-13-14-L450	15	14	-	450	33	-	-	1
PC2232-19-21-L500	22	19	-	500	38	-	-	1

Raccordatura raccomandata - recommended clamping - p.140-141



**PC2263** PROLUNGA PORTAGOMMA ACCIAIO ZINCATO FILETTO MASCHIO BSPT  
GALVANIZED EXTENSION WITH STEEL HOSE TAIL

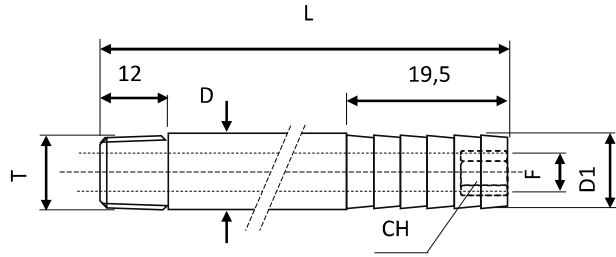

Codice-Code | CH | ØD | F | L | L1 | L2 | T |

PC2263-10-G018-L050	5	10	4,8	50	12	19,5	G 1/8"	1
PC2263-10-G018-L075	5	10	4,8	75	12	19,5	G 1/8"	1
PC2263-10-G018-L100	5	10	4,8	100	12	19,5	G 1/8"	1
PC2263-10-G018-L125	5	10	4,8	125	12	19,5	G 1/8"	1
PC2263-10-G018-L150	5	10	4,8	150	12	19,5	G 1/8"	1
PC2263-10-G018-L200	5	10	4,8	200	12	19,5	G 1/8"	1
PC2263-10-G018-L250	5	10	4,8	250	12	19,5	G 1/8"	1
PC2263-13-G014-L050	7	13	7	50	12	19,5	G 1/4"	1
PC2263-13-G014-L075	7	13	7	75	12	19,5	G 1/4"	1
PC2263-13-G014-L100	7	13	7	100	12	19,5	G 1/4"	1
PC2263-13-G014-L125	7	13	7	125	12	19,5	G 1/4"	1
PC2263-13-G014-L150	7	13	7	150	12	19,5	G 1/4"	1
PC2263-13-G014-L200	7	13	7	200	12	19,5	G 1/4"	1
PC2263-13-G014-L250	7	13	7	250	12	19,5	G 1/4"	1
PC2263-13-G014-L300	7	13	7	300	12	19,5	G 1/4"	1
PC2263-13-G014-L400	7	13	7	400	12	19,5	G 1/4"	1
PC2263-16-G038-L050	10	17	10	50	12	19,5	G 1/4"	1
PC2263-16-G038-L075	10	17	10	75	12	19,5	G 1/4"	1
PC2263-16-G038-L100	10	17	10	100	12	19,5	G 1/4"	1
PC2263-16-G038-L125	10	17	10	125	12	19,5	G 1/4"	1
PC2263-16-G038-L150	10	17	10	150	12	19,5	G 1/4"	1
PC2263-16-G038-L200	10	17	10	200	12	19,5	G 1/4"	1
PC2263-16-G038-L250	10	17	10	250	12	19,5	G 1/4"	1
PC2263-16-G038-L300	10	17	10	300	12	19,5	G 1/4"	1
PC2263-16-G038-L400	10	17	10	400	12	19,5	G 1/4"	1

Raccordatura raccomandata - recommended clamping - p.140-141



**PC2255** VITE CAVA PER RACCORDO AD OCCHIELLO  
BOLT FOR BANJO FITTING

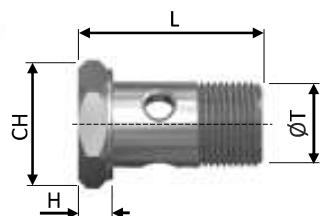

Codice-Code	CH	H	L	T	T1	🛒
PC2255-G018	14	5	26	G1/8"	-	5
PC2255-G014	19	6	33	G1/4"	-	5
PC2255-G038	22	7	39	G3/8"	-	5
PC2255-G012	27	8	46	G1/2"	-	1
PC2255-G034	32	10	56	G3/4"	-	1
PC2255-G100	38	12	72	G1"	-	1

**PC2257** RACCORDO AD OCCHIELLO CON PORTAGOMMA  
BANJO FITTING WITH HOSE TAIL

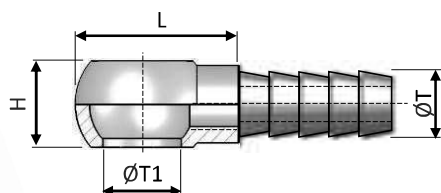

Codice-Code	ØF	H	L	T	T1	🛒
PC2257-06-G014	-	10	25	6-	G1/4"	5
PC2257-10-G014	6	14	29	9,5-	G1/4"	5
PC2257-10-G038	6	20	35	9,5-	G3/8"	5
PC2257-13-G038	8	20	35	12,7-	G3/8"	5
PC2257-13-G012	8	22,5	37	12,7-	G1/2"	1
PC2257-16-G012	9,5	23	37	16-	G1/2"	1
PC2257-16-G034	9,5	30	53	16-	G3/4"	1
PC2257-19-G034	12	38	53	19-	G3/4"	1

**PC2258** RACCORDO AD OCCHIELLO CON PORTAGOMMA EASYLOCK  
BANJO FITTING WITH EASYLOCK HOSE TAIL

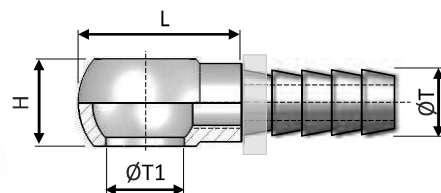

Codice-Code	ØF	H	L	T	T1	🛒
PC2258-10-G018	6	20	-	9,5-	1/8"	5
PC2258-10-G014	6	20	25	9,5-	1/4"	5
PC2258-10-G038	6	20	35	9,5-	3/8"	5
PC2258-13-G038	8	20	35	12,7-	3/8"	5
PC2258-13-G012	8	20	37	12,7-	1/2"	5

**PH1199** RONDELLA BONDED CON GUARNIZIONE  
BONDED RING WITH SEAL

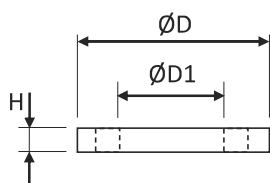

Codice-Code	misura size	ØD	ØD1	tipo O-Ring O-Ring type	H	🛒
PH1199-018-N	1/8"	16	10,4	NBR	2	30
PH1199-018-V	1/8"	16	10,4	FKM	2	15
PH1199-014-N	1/4"	20,5	13,7	NBR	2	30
PH1199-014-V	1/4"	20,5	13,7	FKM	2	15
PH1199-038-N	3/8"	24	17,3	NBR	2	30
PH1199-038-V	3/8"	24	17,3	FKM	2	15
PH1199-012-N	1/2"	28,5	21,5	NBR	2,5	20
PH1199-012-V	1/2"	28,5	21,5	FKM	2,5	10
PH1199-034-N	3/4"	35	27	NBR	2,5	20
PH1199-034-V	3/4"	35	27	FKM	2,5	10
PH1199-100-N	1"	43	33,9	NBR	2,5	5
PH1199-100-V	1"	43	33,9	FKM	2,5	5
PH1199-114-N	1 1/4"	52,5	42,9	NBR	2,5	20
PH1199-114-V	1 1/4"	52,5	42,9	FKM	2,5	10
PH1199-112-N	1 1/2"	58,5	48,4	NBR	2,5	5
PH1199-112-V	1 1/2"	58,5	48,4	FKM	2,5	5

**PH1198** RONDELLA RAME  
COPPER SEAL

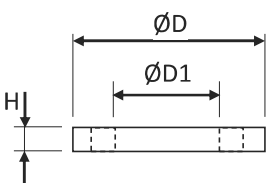

Codice-Code	misura size	ØD	ØD1	tipo O-Ring O-Ring type	H	🛒
PH1198-018	1/8"	16	10	-	1,5	50
PH1198-014	1/4"	19	13,5	-	1,5	50
PH1198-038	3/8"	22	17	-	1,5	50
PH1198-012	1/2"	27	21,5	-	1,5	50
PH1198-034	3/4"	33	27	-	1,5	25
PH1198-100	1"	40	33,5	-	1,5	25
PH1198-114	1 1/4"	50	42	-	1,5	10
PH1198-112	1 1/2"	55	48	-	1,5	10

**CODICI D'ASSIEME PER RACCORDO AD OCCHIELLO CON PORTAGOMMA E RONDELLE BONDED**  
**ASSEMBLY CODES FOR BANJO FITTING WITH HOSE TAIL AND BONDED SEAL**

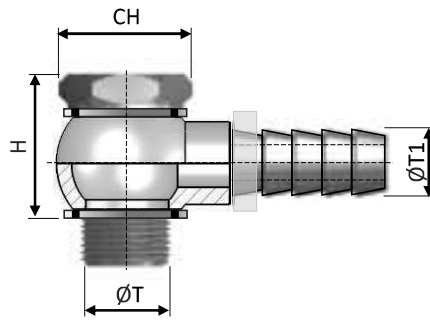
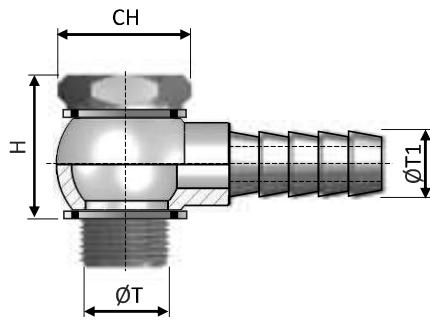

Codice-Code	CH	H	T	T1
PC2257A-06-G014-N	19	24	6-1/4"	G1/4"
PC2257A-06-G014-V			9,5-3/8"	
PC2257A-10-G014-N	22	29	9,5-3/8"	G3/8"
PC2257A-10-G014-V			12,7-1/2"	
PC2257A-10-G038-N	27	36	12,7-1/2"	G1/2"
PC2257A-10-G038-V			16-5/8"	
PC2257A-13-G038-N	32	45	16-5/8"	G3/4"
PC2257A-13-G038-V			19-3/4"	
PC2257A-13-G012-N	27	36	12,7-1/2"	G1/2"
PC2257A-13-G012-V			16-5/8"	
PC2257A-16-G012-N	32	45	16-5/8"	G3/4"
PC2257A-16-G012-V			19-3/4"	
PC2257A-16-G034-N	27	36	12,7-1/2"	G1/2"
PC2257A-16-G034-V			16-5/8"	
PC2257A-19-G034-N	32	45	16-5/8"	G3/4"
PC2257A-19-G034-V			19-3/4"	

Codice-Code	CH	H	T	T1
PC2258A-10-G018-N	14	19	9,5-3/8"	1/8"
PC2258A-10-G018-V			1/4"	
PC2258A-10-G014-N	19	24	9,5-3/8"	1/4"
PC2258A-10-G014-V			3/8"	
PC2258A-10-G038-N	22	29	9,5-3/8"	3/8"
PC2258A-10-G038-V			12,7-1/2"	
PC2258A-13-G038-N	27	36	12,7-1/2"	3/8"
PC2258A-13-G038-V			1/2"	
PC2258A-13-G012-N	27	36	12,7-1/2"	1/2"
PC2258A-13-G012-V			1/2"	

**CODICI D'ASSIEME PER RACCORDO AD OCCHIELLO CON PORTAGOMMA E RONDELLE RAME**  
**ASSEMBLY CODES FOR BANJO FITTING WITH HOSE TAIL AND COPPER SEAL**

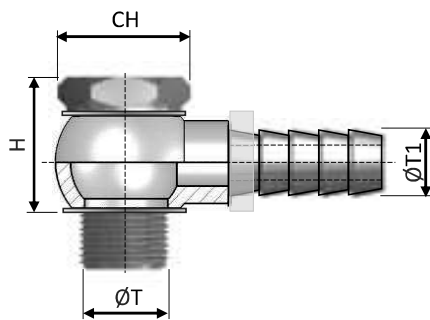
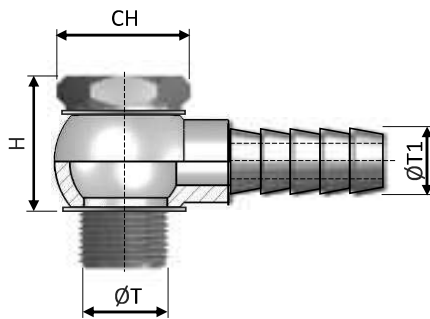

Codice-Code	CH	H	T	T1
PC2257A-06-G014-R	19	23	6-1/4"	G1/4"
PC2257A-10-G014-R			9,5-3/8"	
PC2257A-10-G038-R	22	28	9,5-3/8"	G3/8"
PC2257A-13-G038-R			12,7-1/2"	
PC2257A-13-G012-R	27	34	12,7-1/2"	G1/2"
PC2257A-16-G012-R			16-5/8"	
PC2257A-16-G034-R	32	43	16-5/8"	G3/4"
PC2257A-19-G034-R			19-3/4"	

Codice-Code	CH	H	T	T1
PC2258A-10-G018-R	14	18	9,5-3/8"	1/8"
PC2258A-10-G014-R	19	23	9,5-3/8"	1/4"
PC2258A-10-G038-R	22	28	9,5-3/8"	3/8"
PC2258A-13-G038-R			12,7-1/2"	3/8"
PC2258A-13-G012-R	27	34	12,7-1/2"	1/2"

**PC5102** FASCETTA STRINGITUBI ACCIAIO ZINCATO W1 DIN 3017  
DIN 3017 GALVANIZED STEEL HOSE CLIP W1

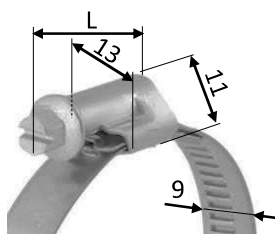

Codice-Code	Campo serraggio - Range		L	
	mm	Inch		
PC5102-0812-W1	8-12	5/16-1/2	21	100
PC5102-1016-W1	10-16	5/16-5/8	21	100
PC5102-1222-W1	12-22	1/2-7/8	24	100
PC5102-1627-W1	16-27	5/8-1 1/16	24	100
PC5102-2032-W1	20-32	13/16-1 1/4	24	50
PC5102-2540-W1	25-40	1-1 9/16	26	50
PC5102-3045-W1	30-45	1 3/16-1	26	50
PC5102-3250-W1	32-50	1 3/8-2	26	50
PC5102-4060-W1	40-60	1 9/16-2	26	25
PC5102-5070-W1	50-70	2-2 3/4	26	25
PC5102-6080-W1	60-80	2 3/8-3 1/8	26	25
PC5102-7090-W1	70-90	3 3/8-3 1/8	26	25
PC5102-8001-W1	80-100	4 3/8-3 1/8	26	25

**PC5104** FASCETTA STRINGITUBI ACCIAIO INOX DIN 3017 ALTE PRESTAZIONI W4  
DIN 3017 STAINLESS STEEL HOSE CLIP W5 HIGH PERFORMANCES W4

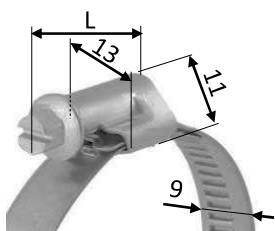

Codice-Code	Campo serraggio - Range		L	
	mm	Inch		
PC5104-0816-W4	8-16	5/16-5/8	21	100
PC5104-1220-W4	12-20	1/2-7/8	24	100
PC5104-1627-W4	16-27	5/8-1 1/16	24	100
PC5104-2032-W4	20-32	13/16-1 1/4	24	100
PC5104-2540-W4	25-40	1-1 9/16	26	100
PC5104-3045-W4	30-45	1 3/16-1	26	50
PC5104-3250-W4	32-50	1 3/8-2	26	50
PC5104-4060-W4	40-60	1 9/16-2	26	50
PC5104-5070-W4	50-70	2-2 3/4	26	25
PC5104-6080-W4	60-80	2 3/8-3 1/8	26	25
PC5104-7090-W4	70-90	2 3/4-3	26	25
PC5104-8001-W4	80-100	3 1/8-3	26	25

**PC5111** FASCETTA STRINGITUBI 9 MM. ACCIAIO INOX W3 CON FRIZIONE  
STAINLESS STEEL HOSE CLIP 9 MM. W3 WITH SPRING RELEASE

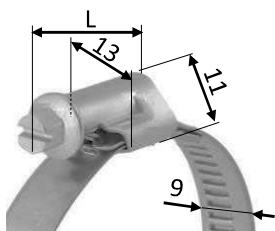

Codice-Code	Campo serraggio - Range		L	
	mm	Inch		
PC5111-0816-W3	8-16	5/16-5/8	21	100
PC5111-1222-W3	12-22	1/2-7/8	24	100
PC5111-1627-W3	16-27	5/8-1 1/16	24	100
PC5111-2032-W3	20-32	13/16-1 1/4	24	100
PC5111-2540-W3	25-40	1-1 9/16	26	100
PC5111-3250-W3	32-50	1 3/16-1	26	50
PC5111-4060-W3	40-60	1 9/16-2	26	50
PC5111-5070-W3	50-70	2-2 3/4	26	25
PC5111-6080-W3	60-80	2 3/8-3 1/8	26	25
PC5111-7090-W3	70-90	2 3/4-3	26	25

**PC5112** FASCETTA STRINGITUBI 12 MM. ACCIAIO INOX W3 CON FRIZIONE  
STAINLESS STEEL HOSE CLIP 12 MM. W3 WITH SPRING RELEASE

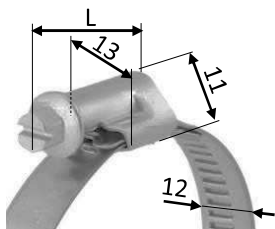

Codice-Code	Campo serraggio - Range		L	
	mm	Inch		
PC5112-1627-W3	16-27	5/8-1 1/16	24	100
PC5112-2032-W3	20-32	13/16-1 1/4	24	100
PC5112-2540-W3	25-40	1-1 9/16	26	100
PC5112-3250-W3	32-50	1 3/16-1	26	50
PC5112-4060-W3	40-60	1 9/16-2	26	50
PC5112-5070-W3	50-70	2-2 3/4	26	25
PC5112-6080-W3	60-80	2 3/8-3 1/8	26	25
PC5112-7090-W3	70-90	2 3/4-3	26	25



**PC5110** FASCETTA A DUE ORECCHIE ACCIAIO ZINCATO DIN 2393 C  
DIN 2393 C GALVANIZED STEEL DOUBLE-HEAR CLIP



Codice-Code	∅D	Range tubo Hose range	H	
PC5110-0507-Z	7.5	5-7	5,5	100
PC5110-0709-Z	9.5	7-9	6	100
PC5110-0911-Z	11.5	9-11	6	100
PC5110-1113-Z	13.5	11-13	6	100
PC5110-1315-Z	15.5	13-15	7	100
PC5110-1417-Z	17.5	14-17	7,5	100
PC5110-1518-Z	18.5	15-18	8	100
PC5110-1720-Z	20.5	17-20	8	100
PC5110-1921-Z	21.5	19-21	8	100
PC5110-2023-Z	23.5	20-23	9	100
PC5110-2225-Z	25.5	22-25	9	100
PC5110-2327-Z	27.5	23-27	9	100
PC5110-2528-Z	28.5	25-28	9	100
PC5110-2731-Z	31.5	27-31	9	100
PC5110-3134-Z	34.5	31-34	9	100
PC5110-3437-Z	37.5	34-37	9	100
PC5110-3740-Z	40.5	37-40	9	100
PC5110-4043-Z	43.5	40-43	9	100

**PC5101** BOCCOLA A PRESSARE IN ACCIAIO ZONCATO PER TUBI BASSA PRESSIONE  
GALVANIZED STEEL FERRULE FOR LOW PRESSURE HOSES

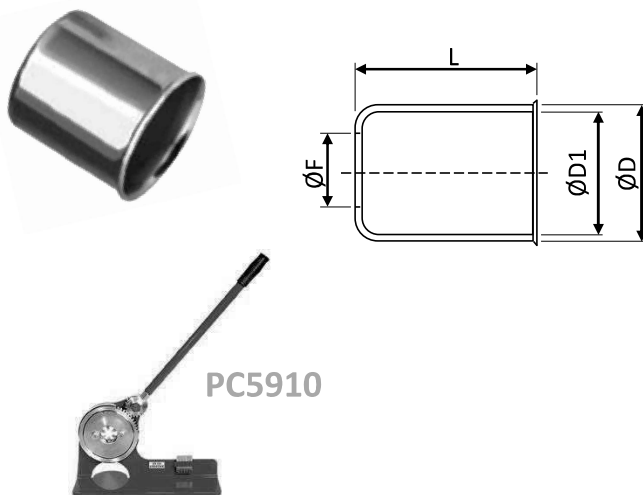

Codice-Code	∅D	∅D1	F	L	
PC5101-125-Z	14	12,5	8,5	17	100
PC5101-135-Z	15,5	13,5	9,3	20	100
PC5101-145-Z	16,5	14,5	10	17	100
PC5101-160-Z	18	16	11,5	17	100
PC5101-180-Z	20	18	13,5	20	100
PC5101-190-Z	21	19	13,9	20	100
PC5101-195-Z	21,5	19,5	14,5	26	100
PC5101-210-Z	23	21	17	26	50
PC5101-220-Z	24	22	17	32	50
PC5101-230-Z	25	23	17	32	50
PC5101-250-Z	27	25	17	32	50
PC5101-280-Z	30	28	20,5	32	50
PC5101-305-Z	32,5	30,5	24,3	33	50
PC5101-330-Z	35	33	24,8	35	50
PC5101-338-Z	40	38	28	35	50
PC5101-410-Z	43	41	30	40	50

**PC5121** BOCCOLA A PRESSARE IN ALLUMINIO PER TUBO BASSA PRESSIONE  
ALLUMINIUM SWAGE FERRULE FOR LOW PRESSURE HOSES

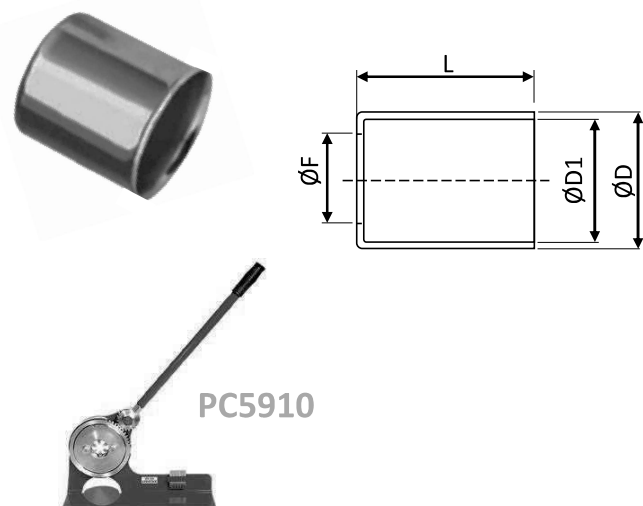

Codice-Code	∅D	∅D1	F	L	
PC5121-140	16	14	-	-	100
PC5121-150	17	15	-	-	100
PC5121-160	18	16	-	-	100
PC5121-180	20	18	-	-	100
PC5121-190	21	19	-	-	100
PC5121-200	22	20	14.8	25	100
PC5121-210	23	21	-	-	50
PC5121-220	24	22	13.8	25	50
PC5121-230	25	23	-	-	50
PC5121-240	26	24	-	-	50
PC5121-260	28	26	18.8	30	50
PC5121-280	30	28	-	-	50
PC5121-300	32	30	-	-	50
PC5121-330	35	33	-	-	50
PC5121-340	36	34	-	-	50
PC5121-360	38	36	-	-	50
PC5121-380	40	38	-	-	50

**PC4601** BOCCOLA A PRESSARE IN ACCIAIO ZINCATO PER TUBO PTFE PC4600  
GALVANIZED STEEL SWAGE FERRULE FOR PTFE HOSE TYPE PC4600

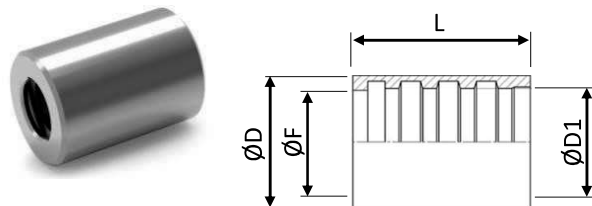

Codice-Code	DN	ØD	ØD1	ØF	L	Ø crimp	
PC4601-014	1/4"	15	11	10,7	30	13	10
PC4601-038	3/8"	18	14,5	14	32	15,5	10
PC4601-012	1/2"	24	19,3	18,6	32	20,5	10
PC4601-034	3/4"	30	24,9	24,4	43	27	8
PC4601-100	1"	36	30,3	30,3	50	34	6
PC4601-114	1"1/4	-	-	-	-	-	4
PC4601-112	1"1/2	-	-	-	-	-	4

**PC4601** BOCCOLA A PRESSARE IN ACCIAIO INOX PER TUBO PTFE PC4600  
STAINLESS STEEL SWAGE FERRULE FOR PTFE HOSE TYPE PC4600

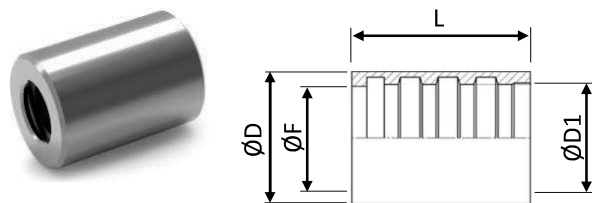

Codice-Code	DN	ØD	ØD1	ØF	L	Ø crimp	
PC4601-014-S	1/4"	15	11	10,7	30	13	10
PC4601-038-S	3/8"	18	14,5	14	32	15,5	10
PC4601-012-S	1/2"	24	19,3	18,6	32	20,5	10
PC4601-034-S	3/4"	30	24,9	24,4	43	27	8
PC4601-100-S	1"	36	30,3	30,3	50	34	6
PC4601-114-S	1"1/4	-	-	-	-	-	4
PC4601-112-S	1"1/2	-	-	-	-	-	4

**PC4651** BOCCOLA A PRESSARE IN ACCIAIO ZINCATO PER TUBO PTFE PC4600  
GALVANIZED STEEL SWAGE FERRULE FOR PTFE HOSE TYPE PC4600

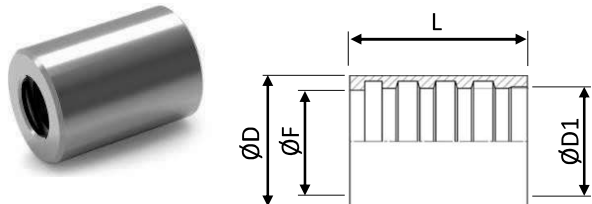

Codice-Code	DN	ØD	ØD1	ØF	L	Ø crimp	
PC4651-014	1/4"	16	12,5	11,2	30	12,2	10
PC4651-038	3/8"	21,5	17,8	15,5	30	16,8	10
PC4651-012	1/2"	25	21	18,6	33	20,2	10
PC4651-034	3/4"	32	28	25,2	40	26,7	8
PC4651-100	1"	40	34,8	33	50	34	6
PC4651-114	1"1/4	-	-	-	-	-	4
PC4651-112	1"1/2	-	-	-	-	-	4

**PC4651** BOCCOLA A PRESSARE IN ACCIAIO INOX PER TUBO PTFE PC4600  
STAINLESS STEEL SWAGE FERRULE FOR PTFE HOSE TYPE PC4600

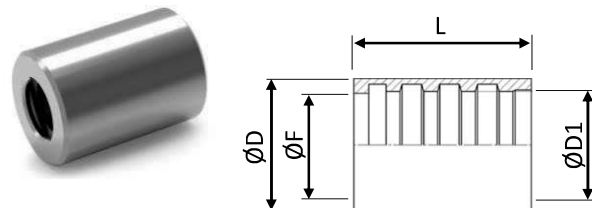

Codice-Code	DN	ØD	ØD1	ØF	L	Ø crimp	
PC4651-014-S	1/4"	16	12,5	11,2	30	12,2	10
PC4651-038-S	3/8"	21,5	17,8	15,5	30	16,8	10
PC4651-012-S	1/2"	25	21	18,6	33	20,2	10
PC4651-034-S	3/4"	32	28	25,2	40	26,7	8
PC4651-100-S	1"	40	34,8	33	50	34	6
PC4651-114-S	1"1/4	-	-	-	-	-	4
PC4651-112-S	1"1/2	-	-	-	-	-	4

**PH1051** BOCCOLA A PRESSARE IN ACCIAIO ZINCATO PER TUBO OLEODINAMICO PH4100 E PH4150  
GALVANIZED STEEL SWAGE FERRULE FOR HYDRAULIC HOSE TYPE PH4100 AND PH4150

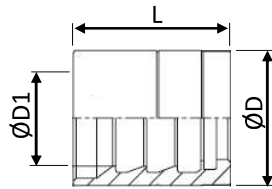

Codice-Code	DN	ØD	ØD1	L	
PH1051-G014-AZ	1/4"	22.5	15.5	25.5	10
PH1051-G038-AZ	3/8"	25	19.4	27	8
PH1051-G012-AZ	1/2"	28	22.6	29	6
PH1051-G034-AZ	3/4"	36	29.7	36	4
PH1051-G100-AZ	1"	45	38.3	44.5	4

**PC4351** BOCCOLA A PRESSARE IN ACCIAIO ZINCATO PER TUBO PC4350  
GALVANIZED STEEL SWAGE FERRULE FOR PC4350 HOSE

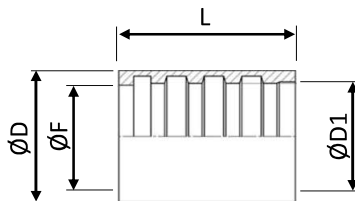

Codice-Code	DN	ØD	ØD1	L	
PC4351-038	3/8"	22	18.4	32	10
PC4351-012	1/2"	28.5	23.6	34	10
PC4351-034	3/4"	38	32.6	40	10
PC4351-100	1"	46	39.5	50	10

**PC4701** BOCCOLA A PRESSARE IN ACCIAIO ZINCATO PER TUBO PC4700 E PC4750  
GALVANIZED STEEL SWAGE FERRULE FOR PC4700 AND PC4750 HOSE

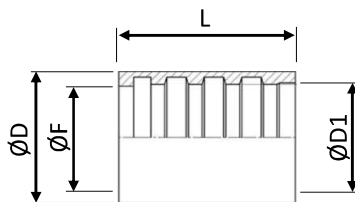

Codice-Code	DN	ØD	ØD1	L	
PC4701-038	3/8"	21	16.8	31	50
PC4701-012	1/2"	25.5	20.8	34	50
PC4701-034	3/4"	32	27.5	42	50
PC4701-100	1"	40	34.5	50	50
PC4701-114	1"1/4	-	-	-	-
PC4701-112	1"1/2	-	-	-	-

**PC5910** ATTREZZATURA MANUALE PER RACCORDATURA BOCCOLE BASSA PRESSIONE PC5101 E PC5121  
HAND-OPERATED CRIMPING TOOL FOR LOW PRESSURE FERRULE AS PC5101 AND 5121



Codice-Code	Range tubo Hose range
-------------	--------------------------

PC5910-028R	o.D. 10-22
-------------	------------

**PC5901** TAGLIATUBI IN ACCIAIO INOX  
STAINLESS STEEL HOSE CUTTER



Codice-Code	Range tubo Hose range
-------------	--------------------------

PC5901-012	0-12
PC5901-028	0-28



PC5901-012R	0-12
PC5901-028R	0-28

**PC5902** UTENSILE PER SERRAGGIO FASCETTE PC5110  
TOOL FOR PC5110 SETTING



PC5902
--------

**PC5801-050** 50 ml SIGILLANTE LIQUIDO 180°C  
**PC5801-250** 250ml LIQUID SEALANG 180°C



Adesivo anaerobico per metalli a leggera resistenza meccanica per sigillare raccordi idraulici e pneumatici fino a 3/4". Per la sigillatura di gas, acqua, GPL, idrocarburi, oli e svariati agenti chimici. E' omologato per gas a norma DIN-DVGW cert. Nr. NG-5146AU0038. E' SMONTABILE con normali utensili. Temperatura di esercizio da -55°C a +180°C. Altamente resistente a corrosione, urti e vibrazioni.

Anaerobic sealant for thread connections allowing easy dismantling of parts. DIN-DVGW approved for gas (Reg. nr. NG 5146AT0263). Upon curing will give an elastic film to replace yarn, PTFE tapes, and solid gaskets for the sealing of gas, air, water, LPG, oils, hydrocarbons and many chemicals. EASY TO DISMANTLE. Shocks and vibrations resistant, it will keep unaffected properties of sealing in the range of temperature from -55°C to +180°C.

**PC5802-050** 50 ml SIGILLANTE LIQUIDO 200°C  
**PC5802-250** 250ml LIQUID SEALANG 200°C



Adesivo anaerobico per metalli a media resistenza per il bloccaggio di dadi e bulloni ed altre parti filettate che richiedono di essere smontati. Oleo-tollerante. Elevata resistenza a corrosione, vibrazioni, acqua, gas, oli e carburanti e molti agenti chimici. Mantiene inalterate le proprietà sigillanti nel campo di temperature tra -55°C e +200°C, fino a +250°C per brevi periodi, con comprovata resistenza allo svitamento alla temperatura di +200°C. Omologato come sigillante per raccordi filettati a tenuta gas DIN-DVGW norma Europea DIN EN 751.

Medium strength anaerobic adhesive for thread locking of nuts and bolts of all types that require to be dismantled. Suitable to be used on oily surfaces. Highly resistant to heat, corrosion, vibrations, water, gas, oils, hydrocarand many chemicals. Approved as gas-tight sealant for threaded fittings according to the European norm EN 751-1. Approved for potable water (TZW – DVGW). It keeps sealing properties unchanged between -55°C/+200°C and up to +250°C for short times.

**PC5803-250** 250ml SIGILLANTE LIQUIDO 250°C  
 LIQUID SEALANG 250°C



Adesivo anaerobico specifico per ottone giallo ad elevata resistenza meccanica per sigillare e bloccare giunzioni filettate e fissare accoppiamenti cilindrici. Mantiene le proprietà sigillanti fino alla temperatura di +250°C. Dotato di alta resistenza a sbalzi termici, vibrazioni, agenti chimici ed invecchiamento. La sua alta viscosità consente una maggiore tolleranza di lavorazione.

Anaerobic adhesive specific for high mechanical strength on yellow brass, to seal threaded joints and to fix cylindrical couplings. It keeps sealing properties up to +250°C. It's highly resistant to thermal shocks, vibrations, chemical agents and aging. Its high viscosity allows a great handling tolerance.